

WALTH

®

Replacement parts suitable for:
CUTLITE PENTA®

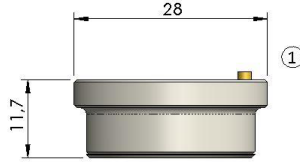

PRECITEC®

POS	REFERENCE NUMBER	WALTH SKU	DESCRIPTION	PKG QTY
1	P0571-1051-00001 - 6930281333 - 080800302	PR059003	PRC-NOZZLE HOLDER KT B2" CON	1

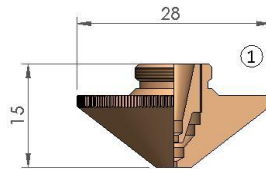

CUTLITE PENTA®

POS	REFERENCE NUMBER	WALTH SKU	DESCRIPTION	PKG QTY
1	080800395	CP071000	CPN-DOUBLE NOZZLE Ø 0.8	1
	080800395	CP071000X	CPN-DOUBLE NOZZLE Ø 0.8 10PK	10
	10.03.11.09.001 - 080800221	CP071001	CPN-DOUBLE NOZZLE Ø 1.0	1
	10.03.11.09.001 - 080800221	CP071001X	CPN-DOUBLE NOZZLE Ø 1.0 10PK	10
	10.03.11.09.002 - 080800222	CP071002	CPN-DOUBLE NOZZLE Ø 1.25	1
	10.03.11.09.002 - 080800222	CP071002X	CPN-DOUBLE NOZZLE Ø 1.25 10PK	10
	10.03.11.09.003 - 080800223	CP071003	CPN-DOUBLE NOZZLE Ø 1.5	1
	10.03.11.09.003 - 080800223	CP071003X	CPN-DOUBLE NOZZLE Ø 1.5 10PK	10
	10.03.11.09.005 - 080800225	CP071004	CPN-DOUBLE NOZZLE Ø 2.0	1
	10.03.11.09.005 - 080800225	CP071004X	CPN-DOUBLE NOZZLE Ø 2.0 10PK	10
	10.03.11.09.006 - 080800226	CP071005	CPN-DOUBLE NOZZLE Ø 2.5	1
	10.03.11.09.006 - 080800226	CP071005X	CPN-DOUBLE NOZZLE Ø 2.5 10PK	10
	10.03.11.09.007 - 080800227	CP071006	CPN-DOUBLE NOZZLE Ø 3.0	1
	10.03.11.09.007 - 080800227	CP071006X	CPN-DOUBLE NOZZLE Ø 3.0 10PK	10
	10.03.11.09.008 - 080800228	CP071007	CPN-DOUBLE NOZZLE Ø 3.5	1
	10.03.11.09.008 - 080800228	CP071007X	CPN-DOUBLE NOZZLE Ø 3.5 10PK	10
	10.03.11.09.021 - 080800229	CP071008	CPN-DOUBLE NOZZLE Ø 4.0	1
	10.03.11.09.021 - 080800229	CP071008X	CPN-DOUBLE NOZZLE Ø 4.0 10PK	10
	10.03.11.09.022 - 080800216	CP071009	CPN-DOUBLE NOZZLE Ø 4.5	1
	10.03.11.09.022 - 080800216	CP071009X	CPN-DOUBLE NOZZLE Ø 4.5 10PK	10

Walth Corporation is not affiliated with the named manufacturers. Reference to machines, parts, descriptions, and model numbers are for convenience in verifying compatibility only. All parts are made by or for Walth Corporation and are not made by the reference manufacturers (unless expressly indicated). All other trademarks are the properties of their respective owners.

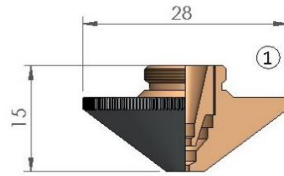

CUTLITE PENTA®				
POS	REFERENCE NUMBER	WALTH SKU	DESCRIPTION	PKG QTY
1		CP071000C	CPN-DOUBLE NOZZLE Ø 0.8 CP	1
		CP071000CX	CPN-DOUBLE NOZZLE Ø 0.8 CP 10PK	10
		CP071001C	CPN-DOUBLE NOZZLE Ø 1.0 CP	1
		CP071001CX	CPN-DOUBLE NOZZLE Ø 1.0 CP 10PK	10
		CP071002C	CPN-DOUBLE NOZZLE Ø 1.25 CP	1
		CP071002CX	CPN-DOUBLE NOZZLE Ø 1.25 CP 10PK	10
		CP071003C	CPN-DOUBLE NOZZLE Ø 1.5 CP	1
		CP071003CX	CPN-DOUBLE NOZZLE Ø 1.5 CP 10PK	10
		CP071004C	CPN-DOUBLE NOZZLE Ø 2.0 CP	1
		CP071004CX	CPN-DOUBLE NOZZLE Ø 2.0 CP 10PK	10
		CP071005C	CPN-DOUBLE NOZZLE Ø 2.5 CP	1
		CP071005CX	CPN-DOUBLE NOZZLE Ø 2.5 CP 10PK	10
		CP071006C	CPN-DOUBLE NOZZLE Ø 3.0 CP	1
		CP071006CX	CPN-DOUBLE NOZZLE Ø 3.0 CP 10PK	10
		CP071007C	CPN-DOUBLE NOZZLE Ø 3.5 CP	1
		CP071007CX	CPN-DOUBLE NOZZLE Ø 3.5 CP 10PK	10
		CP071008C	CPN-DOUBLE NOZZLE Ø 4.0 CP	1
		CP071008CX	CPN-DOUBLE NOZZLE Ø 4.0 CP 10PK	10
		CP071009C	CPN-DOUBLE NOZZLE Ø 4.5 CP	1
	CP071009CX	CPN-DOUBLE NOZZLE Ø 4.5 CP 10PK	10	

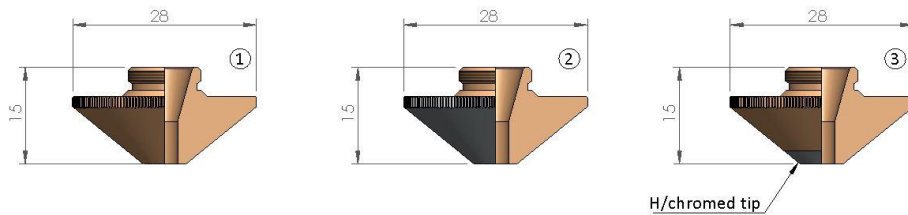

CUTLITE PENTA®				
POS	REFERENCE NUMBER	WALTH SKU	DESCRIPTION	PKG QTY
1	10.03.11.09.015 - 080800235	CP071025X	CPN-NOZZLE Ø 4.0 HD LRG HEAD 10PK	10
	10.03.11.09.016 - 080800236	CP071026X	CPN-NOZZLE Ø 4.5 HD LRG HEAD 10PK	10
	10.03.11.09.030 - 080800237	CP071027X	CPN-NOZZLE Ø 5.0 HD LRG HEAD 10PK	10
2		CP071025C	CPN-NOZZLE Ø 4.0 HD LARGE HEAD CP	1
		CP071025CX	CPN-NZL Ø 4.0 HD LRG HEAD CP 10PK	10
		CP071026C	CPN-NOZZLE Ø 4.5 HD LARGE HEAD CP	1
		CP071026CX	CPN-NZL Ø 4.5 HD LRG HEAD CP 10PK	10
		CP071027C	CPN-NOZZLE Ø 5.0 HD LARGE HEAD CP	1
		CP071027CX	CPN-NZL Ø 5.0 HD LRG HEAD CP 10PK	10
3		CP071025CKX	CPN-NZL Ø 4.0 HD LRG HEAD CP 10PK	10
		CP071026CKX	CPN-NZL Ø 4.5 HD LRG HEAD CP 10PK	10
		CP071027CKX	CPN-NZL Ø 5.0 HD LRG HEAD CP 10PK	10

Walth Corporation is not affiliated with the named manufacturers. Reference to machines, parts, descriptions, and model numbers are for convenience in verifying compatibility only. All parts are made by or for Walth Corporation and are not made by the reference manufactures (unless expressly indicated). All other trademarks are the properties of their respective owners.

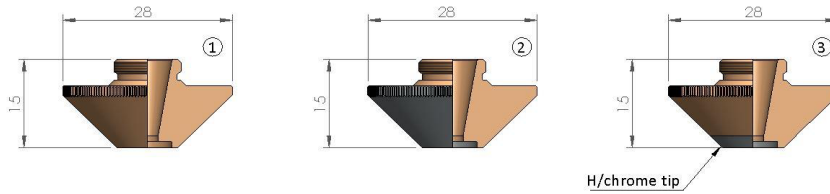

CUTLITE PENTA®				
POS	REFERENCE NUMBER	WALTH SKU	DESCRIPTION	PKG QTY
1	10.03.11.05.083 - 080800219	CP071030X	CPN-NOZZLE Ø 3.5 BOOSTER CUT 10PK	10
	10.03.11.05.084 - 080800220	CP071033X	CPN-NOZZLE Ø 5.0 BOOSTER CUT 10PK	10
	080800218	CP071034X	CPN-NOZZLE Ø 6.0 BOOSTER CUT 10PK	10
	080800392	CP071035X	CPN-NOZZLE Ø 7.0 BOOSTER CUT 10PK	10
2		CP071030CX	CPN-NZL Ø 3.5 BOOSTER CUT CP 10PK	10
		CP071033CX	CPN-NZL Ø 5.0 BOOSTER CUT CP 10PK	10
		CP071034CX	CPN-NZL Ø 6.0 BOOSTER CUT CP 10PK	10
		CP071035CX	CPN-NZL Ø 7.0 BOOSTER CUT CP 10PK	10
3		CP071030CKX	CPN-NZL Ø 3.5 BOOSTER CUT CP 10PK	10
		CP071033CKX	CPN-NZL Ø 5.0 BOOSTER CUT CP 10PK	10
		CP071034CKX	CPN-NZL Ø 6.0 BOOSTER CUT CP 10PK	10
		CP071035CKX	CPN-NZL Ø 7.0 BOOSTER CUT CP 10PK	10



CUTLITE PENTA®				
POS	REFERENCE NUMBER	WALTH SKU	DESCRIPTION	PKG QTY
1	10.03.11.11.004	CP072002X	CPN-DOUBLE NOZZLE Ø 5.0 HQ 10PK	10
2	10.03.11.11.004	CP072002CX	CPN-DOUBLE NOZZLE Ø 5.0 HQ CP 10PK	10

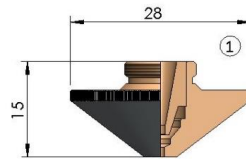

CUTLITE PENTA®				
POS	REFERENCE NUMBER	WALTH SKU	DESCRIPTION	PKG QTY
1	080800245	CP071012C	CPN-DOUBLE NOZZLE Ø 1.2 CP	1
	080800245	CP071012CX	CPN-DOUBLE NOZZLE Ø 1.2 CP 10PK	10
	080800246	CP071013C	CPN-DOUBLE NOZZLE Ø 1.4 CP	1
	080800246	CP071013CX	CPN-DOUBLE NOZZLE Ø 1.4 CP 10PK	10
	080800247	CP071014C	CPN-DOUBLE NOZZLE Ø 1.6 CP	1
	080800247	CP071014CX	CPN-DOUBLE NOZZLE Ø 1.6 CP 10PK	10
	080800248	CP071015C	CPN-DOUBLE NOZZLE Ø 1.8 CP	1
	080800248	CP071015CX	CPN-DOUBLE NOZZLE Ø 1.8 CP 10PK	10
	080800249	CP071016C	CPN-DOUBLE NOZZLE Ø 2.0 CP	1
	080800249	CP071016CX	CPN-DOUBLE NOZZLE Ø 2.0 CP 10PK	10

Walth Corporation is not affiliated with the named manufacturers. Reference to machines, parts, descriptions, and model numbers are for convenience in verifying compatibility only. All parts are made by or for Walth Corporation and are not made by the reference manufacturers (unless expressly indicated). All other trademarks are the properties of their respective owners.

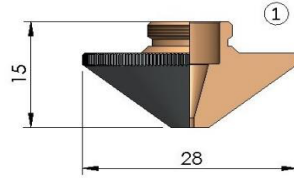

CUTLITE PENTA®				
POS	REFERENCE NUMBER	WALTH SKU	DESCRIPTION	PKG QTY
1	080800304	CP071041C	CPN-NOZZLE Ø 1.0 CP	1
	080800304	CP071041CX	CPN-NOZZLE Ø 1.0 CP 10PK	10
	080800305	CP071042C	CPN-NOZZLE Ø 1.25 CP	1
	080800305	CP071042CX	CPN-NOZZLE Ø 1.25 CP 10PK	10
	080800306	CP071043C	CPN-NOZZLE Ø 1.4 CP	1
	080800306	CP071043CX	CPN-NOZZLE Ø 1.4 CP 10PK	10
	080800307	CP071044C	CPN-NOZZLE Ø 1.5 CP	1
	080800307	CP071044CX	CPN-NOZZLE Ø 1.5 CP 10PK	10
	080800308	CP071045C	CPN-NOZZLE Ø 1.6 CP	1
	080800308	CP071045CX	CPN-NOZZLE Ø 1.6 CP 10PK	10
	080800309	CP071046C	CPN-NOZZLE Ø 1.7 CP	1
	080800309	CP071046CX	CPN-NOZZLE Ø 1.7 CP 10PK	10
	080800310	CP071047C	CPN-NOZZLE Ø 1.8 CP	1
	080800310	CP071047CX	CPN-NOZZLE Ø 1.8 CP 10PK	10

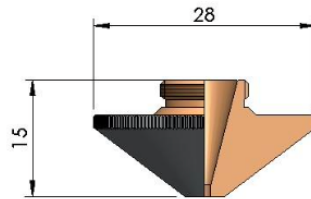

PRECITEC® / CUTLITE PENTA®				
POS	REFERENCE NUMBER	WALTH SKU	DESCRIPTION	PKG QTY
1		PR071105C	PRC-NOZZLE Ø 1.5 HD CP	1
		PR071105CX	PRC-NOZZLE Ø 1.5 HD CP 10PK	10
		PR071107C	PRC-NOZZLE Ø 2.0 HD CP	1
		PR071107CX	PRC-NOZZLE Ø 2.0 HD CP 10PK	10
		CP071148C	CPN-NOZZLE Ø 2.1 CP	1
		CP071148CX	CPN-NOZZLE Ø 2.1 CP 10PK	10
		CP071149C	CPN-NOZZLE Ø 2.2 CP	1
		CP071149CX	CPN-NOZZLE Ø 2.2 CP 10PK	10
		CP071150C	CPN-NOZZLE Ø 2.3 CP	1
		CP071150CX	CPN-NOZZLE Ø 2.3 CP 10PK	10
		CP071151C	CPN-NOZZLE Ø 2.4 CP	1
		CP071151CX	CPN-NOZZLE Ø 2.4 CP 10PK	10

Walth Corporation is not affiliated with the named manufacturers. Reference to machines, parts, descriptions, and model numbers are for convenience in verifying compatibility only. All parts are made by or for Walth Corporation and are not made by the reference manufacturers (unless expressly indicated). All other trademarks are the properties of their respective owners.

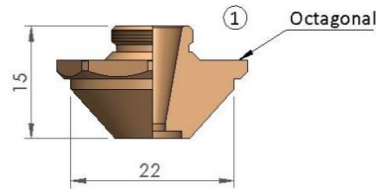

CUTLITE PENTA®

POS	REFERENCE NUMBER	WALTH SKU	DESCRIPTION	PKG QTY
1	080800296	CP071036	CPN-NOZZLE Ø 3.5 BOOSTER CUT	1
	080800296	CP071036X	CPN-NOZZLE Ø 3.5 BOOSTER CUT 10PK	10
	080800349	CP071039	CPN-NOZZLE Ø 5.0 BOOSTER CUT	1
	080800349	CP071039X	CPN-NOZZLE Ø 5.0 BOOSTER CUT 10PK	10
	080800385	CP071040	CPN-NOZZLE Ø 6.0 BOOSTER CUT	1
	080800385	CP071040X	CPN-NOZZLE Ø 6.0 BOOSTER CUT 10PK	10
	080800407	CP071038	CPN-NOZZLE Ø 7.0 BOOSTER CUT	1
	080800407	CP071038X	CPN-NOZZLE Ø 7.0 BOOSTER CUT 10PK	10

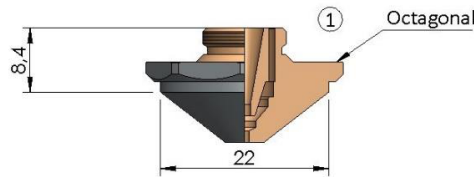

CUTLITE PENTA®

POS	REFERENCE NUMBER	WALTH SKU	DESCRIPTION	PKG QTY
1	080800297	CP071018C	CPN-DOUBLE NOZZLE Ø 1.2 CP	1
	080800297	CP071018CX	CPN-DOUBLE NOZZLE Ø 1.2 CP 10PK	10
	080800298	CP071019C	CPN-DOUBLE NOZZLE Ø 1.4 CP	1
	080800298	CP071019CX	CPN-DOUBLE NOZZLE Ø 1.4 CP 10PK	10
	080800299	CP071020C	CPN-DOUBLE NOZZLE Ø 1.6 CP	1
	080800299	CP071020CX	CPN-DOUBLE NOZZLE Ø 1.6 CP 10PK	10
	080800300	CP071021C	CPN-DOUBLE NOZZLE Ø 1.8 CP	1
	080800300	CP071021CX	CPN-DOUBLE NOZZLE Ø 1.8 CP 10PK	10
		CP071022C	CPN-DOUBLE NOZZLE Ø 2.0 CP	1
		CP071022CX	CPN-DOUBLE NOZZLE Ø 2.0 CP 10PK	10

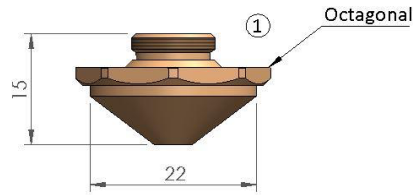

CUTLITE PENTA®				
POS	REFERENCE NUMBER	WALTH SKU	DESCRIPTION	PKG QTY
1	080800406	CP071050	CPN-DOUBLE NOZZLE Ø 0.8	1
	080800406	CP071050X	CPN-DOUBLE NOZZLE Ø 0.8 10PK	10
	080800347	CP071051	CPN-DOUBLE NOZZLE Ø 1.0	1
	080800347	CP071051X	CPN-DOUBLE NOZZLE Ø 1.0 10PK	10
	080800348	CP071052	CPN-DOUBLE NOZZLE Ø 1.25	1
	080800348	CP071052X	CPN-DOUBLE NOZZLE Ø 1.25 10PK	10
	080800375	CP071053	CPN-DOUBLE NOZZLE Ø 1.5	1
	080800375	CP071053X	CPN-DOUBLE NOZZLE Ø 1.5 10PK	10
	080800376	CP071054	CPN-DOUBLE NOZZLE Ø 2.0	1
	080800376	CP071054X	CPN-DOUBLE NOZZLE Ø 2.0 10PK	10
	080800350	CP071055	CPN-DOUBLE NOZZLE Ø 2.5	1
	080800350	CP071055X	CPN-DOUBLE NOZZLE Ø 2.5 10PK	10
	080800351	CP071056	CPN-DOUBLE NOZZLE Ø 3.0	1
	080800351	CP071056X	CPN-DOUBLE NOZZLE Ø 3.0 10PK	10
	080800352	CP071057	CPN-DOUBLE NOZZLE Ø 3.5	1
	080800352	CP071057X	CPN-DOUBLE NOZZLE Ø 3.5 10PK	10
	080800353	CP071058	CPN-DOUBLE NOZZLE Ø 4.0	1
	080800353	CP071058X	CPN-DOUBLE NOZZLE Ø 4.0 10PK	10
	080800377	CP071059	CPN-DOUBLE NOZZLE Ø 4.5	1
	080800377	CP071059X	CPN-DOUBLE NOZZLE Ø 4.5 10PK	10
080800378	CP071060	CPN-DOUBLE NOZZLE Ø 5.0	1	
080800378	CP071060X	CPN-DOUBLE NOZZLE Ø 5.0 10PK	10	

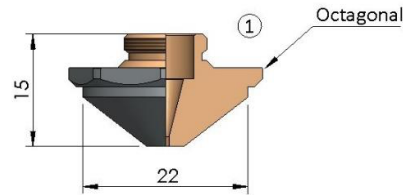

CUTLITE PENTA®				
POS	REFERENCE NUMBER	WALTH SKU	DESCRIPTION	PKG QTY
1		CP071081C	CPN-NOZZLE Ø 1.0 CP	1
		CP071081CX	CPN-NOZZLE Ø 1.0 CP 10PK	10
	080800379	CP071082C	CPN-NOZZLE Ø 1.25 CP	1
	080800379	CP071082CX	CPN-NOZZLE Ø 1.25 CP 10PK	10
	080800380	CP071083C	CPN-NOZZLE Ø 1.4 CP	1
	080800380	CP071083CX	CPN-NOZZLE Ø 1.4 CP 10PK	10
		CP071084C	CPN-NOZZLE Ø 1.5 CP	1
		CP071084CX	CPN-NOZZLE Ø 1.5 CP 10PK	10
	080800381	CP071085C	CPN-NOZZLE Ø 1.6 CP	1
	080800381	CP071085CX	CPN-NOZZLE Ø 1.6 CP 10PK	10
		CP071086C	CPN-NOZZLE Ø 1.7 CP	1
		CP071086CX	CPN-NOZZLE Ø 1.7 CP 10PK	10
	080800382	CP071087C	CPN-NOZZLE Ø 1.8 CP	1
	080800382	CP071087CX	CPN-NOZZLE Ø 1.8 CP 10PK	10

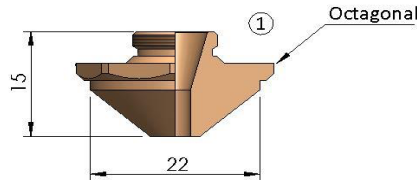

CUTLITE PENTA®				
POS	REFERENCE NUMBER	WALTH SKU	DESCRIPTION	PKG QTY
1	080800372	CP071091	CPN-NOZZLE Ø 4.0	1
	080800372	CP071091X	CPN-NOZZLE Ø 4.0 10PK	10
	080800373	CP071092	CPN-NOZZLE Ø 4.5	1
	080800373	CP071092X	CPN-NOZZLE Ø 4.5 10PK	10
	080800374	CP071093	CPN-NOZZLE Ø 5.0	1
	080800374	CP071093X	CPN-NOZZLE Ø 5.0 10PK	10

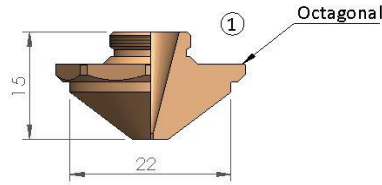

CUTLITE PENTA®					
POS	REFERENCE NUMBER	WALTH SKU	DESCRIPTION	PKG QTY	
1		CP071063	CPN-NOZZLE Ø 0.8 HD	1	
		CP071063X	CPN-NOZZLE Ø 0.8 HD 10PK	10	
		CP071064	CPN-NOZZLE Ø 1.0 HD	1	
		CP071064X	CPN-NOZZLE Ø 1.0 HD 10PK	10	
		CP071065	CPN-NOZZLE Ø 1.2 HD	1	
		CP071065X	CPN-NOZZLE Ø 1.2 HD 10PK	10	
		CP071066	CPN-NOZZLE Ø 1.4 HD	1	
		CP071066X	CPN-NOZZLE Ø 1.4 HD 10PK	10	
		080800369	CP071067	CPN-NOZZLE Ø 1.5 HD	1
		080800369	CP071067X	CPN-NOZZLE Ø 1.5 HD 10PK	10
			CP071068	CPN-NOZZLE Ø 1.8 HD	1
			CP071068X	CPN-NOZZLE Ø 1.8 HD 10PK	10
		080800301	CP071069	CPN-NOZZLE Ø 2.0 HD	1
		080800301	CP071069X	CPN-NOZZLE Ø 2.0 HD 10PK	10
			CP071171	CPN-NOZZLE Ø 2.1 HD	1
			CP071171X	CPN-NOZZLE Ø 2.1 HD 10PK	10
			CP071172	CPN-NOZZLE Ø 2.2 HD	1
			CP071172X	CPN-NOZZLE Ø 2.2 HD 10PK	10
		080800411	CP071070	CPN-NOZZLE Ø 2.3 HD	1
		080800411	CP071070X	CPN-NOZZLE Ø 2.3 HD 10PK	10
			CP071174	CPN-NOZZLE Ø 2.4 HD	1
			CP071174X	CPN-NOZZLE Ø 2.4 HD 10PK	10
		080800354	CP071071	CPN-NOZZLE Ø 2.5 HD	1
		080800354	CP071071X	CPN-NOZZLE Ø 2.5 HD 10PK	10
			CP071072	CPN-NOZZLE Ø 2.75 HD	1
			CP071072X	CPN-NOZZLE Ø 2.75 HD 10PK	10
		080800370	CP071073	CPN-NOZZLE Ø 3.0 HD	1
		080800370	CP071073X	CPN-NOZZLE Ø 3.0 HD 10PK	10
			CP071074	CPN-NOZZLE Ø 3.2 HD	1
			CP071074X	CPN-NOZZLE Ø 3.2 HD 10PK	10
		080800371	CP071075	CPN-NOZZLE Ø 3.5 HD	1
		080800371	CP071075X	CPN-NOZZLE Ø 3.5 HD 10PK	10
		CP071076	CPN-NOZZLE Ø 4.0 HD	1	
		CP071076X	CPN-NOZZLE Ø 4.0 HD 10PK	10	
		CP071077	CPN-NOZZLE Ø 4.5 HD	1	
		CP071077X	CPN-NOZZLE Ø 4.5 HD 10PK	10	
		CP071078	CPN-NOZZLE Ø 5.0 HD	1	
		CP071078X	CPN-NOZZLE Ø 5.0 HD 10PK	10	

Walth Corporation is not affiliated with the named manufacturers. Reference to machines, parts, descriptions, and model numbers are for convenience in verifying compatibility only. All parts are made by or for Walth Corporation and are not made by the reference manufacturers (unless expressly indicated). All other trademarks are the properties of their respective owners.

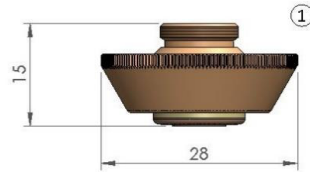

CUTLITE PENTA®				
POS	REFERENCE NUMBER	WALTH SKU	DESCRIPTION	PKG QTY
1	080800356	CP072010	CPN-TOUCHDOWN NOZZLE	1

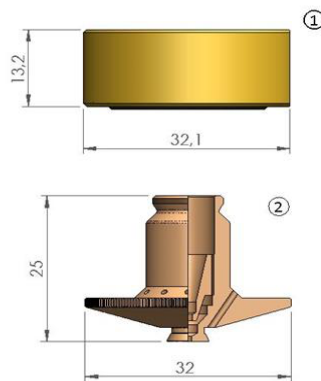

CUTLITE PENTA®				
POS	REFERENCE NUMBER	WALTH SKU	DESCRIPTION	PKG QTY
1	T10L0096B-080800265	CP079001	CPN-ADAPTER COOLTECH V2	1
2		CP073003	CPN-DOUBLE NOZZLE Ø 1.0	1
	080800254	CP073004	CPN-DOUBLE NOZZLE Ø 1.2	1
	080800255	CP073010	CPN-DOUBLE NOZZLE Ø 2.5	1
	080800256	CP073012	CPN-DOUBLE NOZZLE Ø 3.0	1
	080800257	CP073013	CPN-DOUBLE NOZZLE Ø 3.5	1
	080800258	CP073014	CPN-DOUBLE NOZZLE Ø 4.0	1
	080800259	CP073015	CPN-DOUBLE NOZZLE Ø 4.5	1

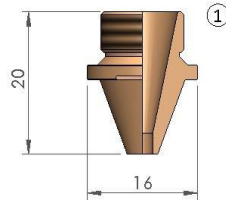

CUTLITE PENTA®				
POS	REFERENCE NUMBER	WALTH SKU	DESCRIPTION	PKG QTY
1	080800303	CP074004X	CPN-NOZZLE Ø 2.0 10PK	10
	080800273	CP074006X	CPN-NOZZLE Ø 3.0 10PK	10
	080800274	CP074008X	CPN-NOZZLE Ø 4.0 10PK	10
	080800275	CP074010X	CPN-NOZZLE Ø 5.0 10PK	10

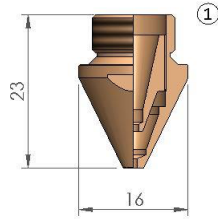

CUTLITE PENTA®				
POS	REFERENCE NUMBER	WALTH SKU	DESCRIPTION	PKG QTY
1	080800276	CP074013X	CPN-DOUBLE NOZZLE Ø 1.2 10PK	10
	080800277	CP074014X	CPN-DOUBLE NOZZLE Ø 1.4 10PK	10
	080800278	CP074015X	CPN-DOUBLE NOZZLE Ø 1.6 10PK	10
	080800279	CP074016X	CPN-DOUBLE NOZZLE Ø 2.0 10PK	10
	080800280	CP074017X	CPN-DOUBLE NOZZLE Ø 2.5 10PK	10
	080800281	CP074018X	CPN-DOUBLE NOZZLE Ø 3.0 10PK	10
	080800282	CP074019X	CPN-DOUBLE NOZZLE Ø 3.5 10PK	10
	080800283	CP074020X	CPN-DOUBLE NOZZLE Ø 4.0 10PK	10

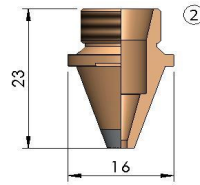
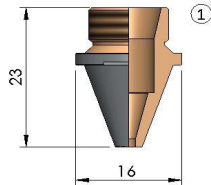

CUTLITE PENTA®				
POS	REFERENCE NUMBER	WALTH SKU	DESCRIPTION	PKG QTY
1		CP074031CX	CPN-NOZZLE Ø 1.0 CP 10PK	10
		CP074032CX	CPN-NOZZLE Ø 1.25 CP 10PK	10
		CP074033CX	CPN-NOZZLE Ø 1.4 CP 10PK	10
		CP074034CX	CPN-NOZZLE Ø 1.5 CP 10PK	10
		CP074035CX	CPN-NOZZLE Ø 1.6 CP 10PK	10
		CP074036CX	CPN-NOZZLE Ø 1.7 CP 10PK	10
		CP074037CX	CPN-NOZZLE Ø 1.8 CP 10PK	10
2		CP074031CKX	CPN-NOZZLE Ø 1.0 CP 10PK	10
		CP074032CKX	CPN-NOZZLE Ø 1.25 CP 10PK	10
		CP074033CKX	CPN-NOZZLE Ø 1.4 CP 10PK	10
		CP074034CKX	CPN-NOZZLE Ø 1.5 CP 10PK	10
		CP074035CKX	CPN-NOZZLE Ø 1.6 CP 10PK	10
		CP074036CKX	CPN-NOZZLE Ø 1.7 CP 10PK	10
	CP074037CKX	CPN-NOZZLE Ø 1.8 CP 10PK	10	

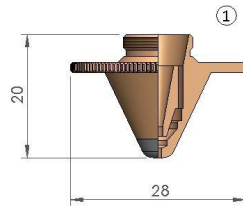

CUTLITE PENTA®				
POS	REFERENCE NUMBER	WALTH SKU	DESCRIPTION	PKG QTY
1	074024	CP074024CK	CPN-DOUBLE NOZZLE Ø 1.2 CP	1
		CP074024CKV	CPN-DOUBLE NOZZLE Ø 1.2 CP 5PK	5
		CP074025CK	CPN-DOUBLE NOZZLE Ø 1.4 CP	1
		CP074025CKV	CPN-DOUBLE NOZZLE Ø 1.4 CP 5PK	5
		CP074026CK	CPN-DOUBLE NOZZLE Ø 1.6 CP	1
		CP074026CKV	CPN-DOUBLE NOZZLE Ø 1.6 CP 5PK	5
		CP074027CK	CPN-DOUBLE NOZZLE Ø 1.8 CP	1
		CP074027CKV	CPN-DOUBLE NOZZLE Ø 1.8 CP 5PK	5
		CP074028CK	CPN-DOUBLE NOZZLE Ø 2.0 CP	1
		CP074028CKV	CPN-DOUBLE NOZZLE Ø 2.0 CP 5PK	5

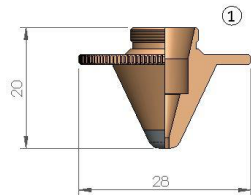

CUTLITE PENTA®				
POS	REFERENCE NUMBER	WALTH SKU	DESCRIPTION	PKG QTY
1	074043	CP074043CK	CPN-NOZZLE Ø 1.4 CP	1
		CP074043CKV	CPN-NOZZLE Ø 1.4 CP 5PK	5
		CP074044CK	CPN-NOZZLE Ø 1.5 CP	1
		CP074044CKV	CPN-NOZZLE Ø 1.5 CP 5PK	5
		CP074045CK	CPN-NOZZLE Ø 1.6 CP	1
		CP074045CKV	CPN-NOZZLE Ø 1.6 CP 5PK	5

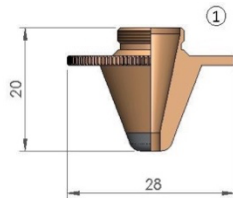

CUTLITE PENTA®					
POS	REFERENCE NUMBER	WALTH SKU	DESCRIPTION	PKG QTY	
1		CP074055CK	CPN-NOZZLE Ø 3.0 CP	1	
		CP074055CKV	CPN-NOZZLE Ø 3.0 CP 5PK	5	
		CP074057CK	CPN-NOZZLE Ø 4.0 CP	1	
		CP074057CKV	CPN-NOZZLE Ø 4.0 CP 5PK	5	
		074059CK	CP074059CK	CPN-NOZZLE Ø 5.0 CP	1
			CP074059CKV	CPN-NOZZLE Ø 5.0 CP 5PK	5

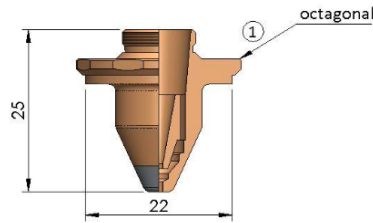

CUTLITE PENTA®					
POS	REFERENCE NUMBER	WALTH SKU	DESCRIPTION	PKG QTY	
1	080800361	CP074064CK	CPN-DOUBLE NOZZLE Ø 1.2 CP	1	
	080800361	CP074064CKV	CPN-DOUBLE NOZZLE Ø 1.2 CP 5PK	5	
	080800362	CP074065CK	CPN-DOUBLE NOZZLE Ø 1.4 CP	1	
	080800362	CP074065CKV	CPN-DOUBLE NOZZLE Ø 1.4 CP 5PK	5	
	080800363	CP074066CK	CPN-DOUBLE NOZZLE Ø 1.6 CP	1	
	080800363	CP074066CKV	CPN-DOUBLE NOZZLE Ø 1.6 CP 5PK	5	
	080800364	CP074067CK	CPN-DOUBLE NOZZLE Ø 1.8 CP	1	
	080800364	CP074067CKV	CPN-DOUBLE NOZZLE Ø 1.8 CP 5PK	5	
			CP074068CK	CPN-DOUBLE NOZZLE Ø 2.0 CP	1
			CP074068CKV	CPN-DOUBLE NOZZLE Ø 2.0 CP 5PK	5

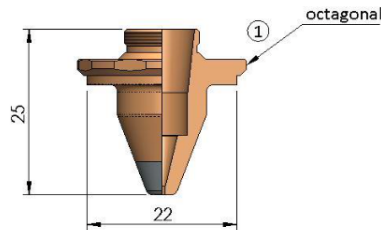

CUTLITE PENTA®				
POS	REFERENCE NUMBER	WALTH SKU	DESCRIPTION	PKG QTY
1		CP074071CK	CPN-NOZZLE Ø 1.0 CP	1
		CP074071CKV	CPN-NOZZLE Ø 1.0 CP 5PK	5
		CP074072CK	CPN-NOZZLE Ø 1.2 CP	1
		CP074072CKV	CPN-NOZZLE Ø 1.2 CP 5PK	5
	080800358	CP074073CK	CPN-NOZZLE Ø 1.4 CP	1
	080800358	CP074073CKV	CPN-NOZZLE Ø 1.4 CP 5PK	5
		CP074074CK	CPN-NOZZLE Ø 1.5 CP	1
		CP074074CKV	CPN-NOZZLE Ø 1.5 CP 5PK	5
	080800359	CP074075CK	CPN-NOZZLE Ø 1.6 CP	1
	080800359	CP074075CKV	CPN-NOZZLE Ø 1.6 CP 5PK	5
		CP074076CK	CPN-NOZZLE Ø 1.7 CP	1
		CP074076CKV	CPN-NOZZLE Ø 1.7 CP 5PK	5
	080800360	CP074077CK	CPN-NOZZLE Ø 1.8 CP	1
	080800360	CP074077CKV	CPN-NOZZLE Ø 1.8 CP 5PK	5
	080800384	CP074128CK	CPN-NOZZLE Ø 2.0 CP	1
	080800384	CP074128CKV	CPN-NOZZLE Ø 2.0 CP 5PK	5

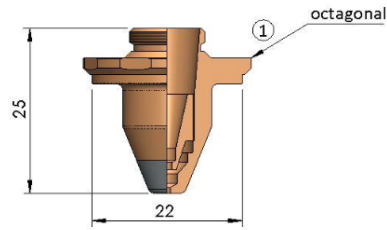

CUTLITE PENTA®				
POS	REFERENCE NUMBER	WALTH SKU	DESCRIPTION	PKG QTY
1	080800404	CP074094CK	CPN-DOUBLE NOZZLE Ø 0.8 CP	1
	080800404	CP074094CKV	CPN-DOUBLE NOZZLE Ø 0.8 CP 5PK	5
	080800403	CP074085CK	CPN-DOUBLE NOZZLE Ø 1.0 CP	1
	080800403	CP074085CKV	CPN-DOUBLE NOZZLE Ø 1.0 CP 5PK	5
		CP074086CK	CPN-DOUBLE NOZZLE Ø 1.25 CP	1
		CP074086CKV	CPN-DOUBLE NOZZLE Ø 1.25 CP 5PK	5
		CP074087CK	CPN-DOUBLE NOZZLE Ø 1.5 CP	1
		CP074087CKV	CPN-DOUBLE NOZZLE Ø 1.5 CP 5PK	5
		CP074088CK	CPN-DOUBLE NOZZLE Ø 2.0 CP	1
		CP074088CKV	CPN-DOUBLE NOZZLE Ø 2.0 CP 5PK	5
		CP074089CK	CPN-DOUBLE NOZZLE Ø 2.5 CP	1
		CP074089CKV	CPN-DOUBLE NOZZLE Ø 2.5 CP 5PK	5
		CP074090CK	CPN-DOUBLE NOZZLE Ø 3.0 CP	1
		CP074090CKV	CPN-DOUBLE NOZZLE Ø 3.0 CP 5PK	5
		CP074091CK	CPN-DOUBLE NOZZLE Ø 3.5 CP	1
		CP074091CKV	CPN-DOUBLE NOZZLE Ø 3.5 CP 5PK	5
		CP074092CK	CPN-DOUBLE NOZZLE Ø 4.0 CP	1
		CP074092CKV	CPN-DOUBLE NOZZLE Ø 4.0 CP 5PK	5
		CP074093CK	CPN-DOUBLE NOZZLE Ø 4.5 CP	1
		CP074093CKV	CPN-DOUBLE NOZZLE Ø 4.5 CP 5PK	5

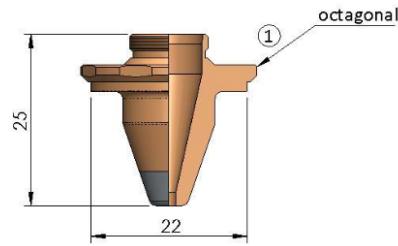

CUTLITE PENTA®				
POS	REFERENCE NUMBER	WALTH SKU	DESCRIPTION	PKG QTY
1	080800396	CP074101CK	CPN-NOZZLE Ø 1.5 CP	1
	080800396	CP074101CKV	CPN-NOZZLE Ø 1.5 CP 5PK	5
	080800384	CP074078CK	CPN-NOZZLE Ø 2.0 CP	1
	080800384	CP074078CKV	CPN-NOZZLE Ø 2.0 CP 5PK	5
	080800398	CP074109CK	CPN-NOZZLE Ø 2.1 CP	1
	080800398	CP074109CKV	CPN-NOZZLE Ø 2.1 CP 5PK	5
	080800399	CP074110CK	CPN-NOZZLE Ø 2.2 CP	1
	080800399	CP074110CKV	CPN-NOZZLE Ø 2.2 CP 5PK	5
	080800400	CP074111CK	CPN-NOZZLE Ø 2.3 CP	1
	080800400	CP074111CKV	CPN-NOZZLE Ø 2.3 CP 5PK	5
	080800401	CP074112CK	CPN-NOZZLE Ø 2.4 CP	1
	080800401	CP074112CKV	CPN-NOZZLE Ø 2.4 CP 5PK	5
	080800365	CP074079CK	CPN-NOZZLE Ø 3.0 CP	1
	080800365	CP074079CKV	CPN-NOZZLE Ø 3.0 CP 5PK	5
	080800366	CP074081CK	CPN-NOZZLE Ø 4.0 CP	1
	080800366	CP074081CKV	CPN-NOZZLE Ø 4.0 CP 5PK	5
	080800386	CP074083CK	CPN-NOZZLE Ø 5.0 CP	1
	080800386	CP074083CKV	CPN-NOZZLE Ø 5.0 CP 5PK	5
	080800397	CP074084CK	CPN-NOZZLE Ø 6.0 CP	1
	080800397	CP074084CKV	CPN-NOZZLE Ø 6.0 CP 5PK	5
080800416	CP074082CK	CPN-NOZZLE Ø 7.0 CP	1	
080800416	CP074082CKV	CPN-NOZZLE Ø 7.0 CP 5PK	5	

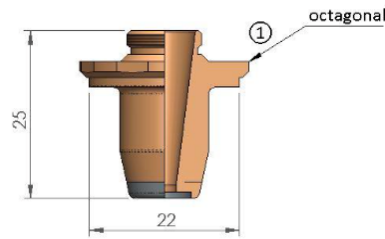

CUTLITE PENTA®					
POS	REFERENCE NUMBER	WALTH SKU	DESCRIPTION	PKG QTY	
1	080800367	CP074096CK	CPN-NOZZLE Ø 3.5 CP	1	
	080800367	CP074096CKV	CPN-NOZZLE Ø 3.5 CP 5PK	5	
	080800368	CP074097CK	CPN-NOZZLE Ø 5.0 CP	1	
	080800368	CP074097CKV	CPN-NOZZLE Ø 5.0 CP 5PK	5	
	080800383	CP074098CK	CPN-NOZZLE Ø 6.0 CP	1	
	080800383	CP074098CKV	CPN-NOZZLE Ø 6.0 CP 5PK	5	
			CP074099CK	CPN-NOZZLE Ø 7.0 CP	1
			CP074099CKV	CPN-NOZZLE Ø 7.0 CP 5PK	5

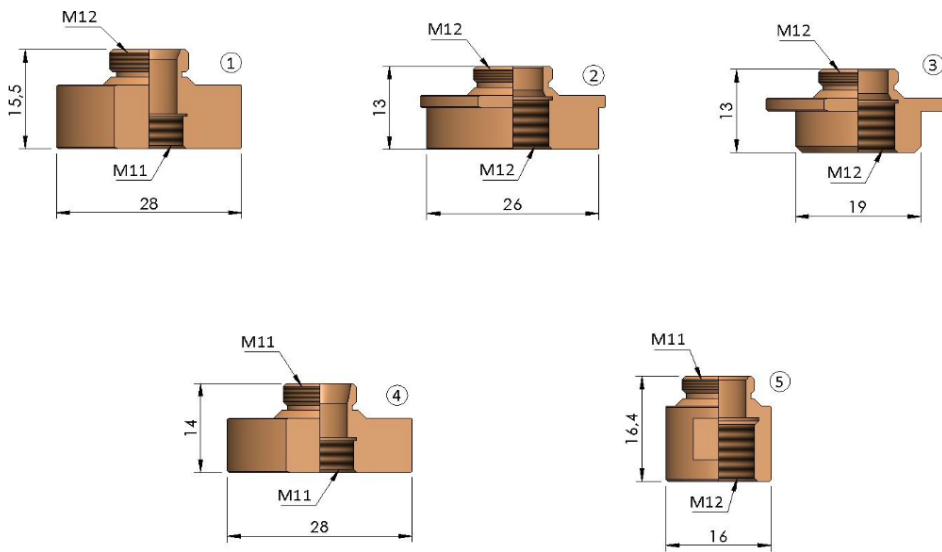

CUTLITE PENTA®				
POS	REFERENCE NUMBER	WALTH SKU	DESCRIPTION	PKG QTY
1		CP079010	CPN-ADAPTER EXTENTION	1
2		CP079011	CPN-ADAPTER	1
3		CP079012	CPN-ADAPTER EXTENTION	1
4		CP079013	CPN-ADAPTER	1
5		CP079014	CPN-ADAPTER	1

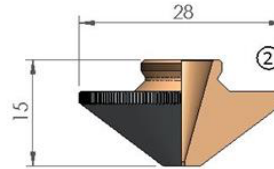
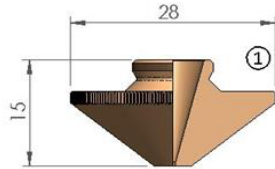

PRECITEC®				
POS	REFERENCE NUMBER	WALTH SKU	DESCRIPTION	PKG QTY
1	P0591-573-00015 - 281463 - 29100235 - 080800230	PR051006X	PRC-NOZZLE Ø 1.5 HD 10PK	10
	10.03.11.09.011-281550-P0591-575-00020-29100237-080800231	PR051008X	PRC-NOZZLE Ø 2.0 HD 10PK	10
	10.03.11.09.012-281551-P0591-576-00025-29100239-080800232	PR051010X	PRC-NOZZLE Ø 2.5 HD 10PK	10
	P0591-577-00030 10.03.11.09.013-29100241-080800233	PR051012X	PRC-NOZZLE Ø 3.0 HD 10PK	10
	10.03.11.09.014 - 29100243 - 080800234	PR051014X	PRC-NOZZLE Ø 3.5 HD 10PK	10
2	281463 - P0591-573-00015	PR051006CX	PRC-NOZZLE Ø 1.5 HD CP 10PK	10
	281550 - P0591-575-00020	PR051008CX	PRC-NOZZLE Ø 2.0 HD CP 10PK	10
	281551 - P0591-576-00025	PR051010CX	PRC-NOZZLE Ø 2.5 HD CP 10PK	10
		PR051012CX	PRC-NOZZLE Ø 3.0 HD CP 10PK	10
		PR051014CX	PRC-NOZZLE Ø 3.5 HD CP 10PK	10

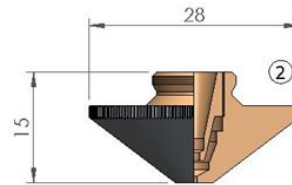
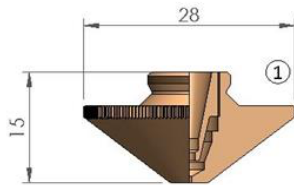

PRECITEC®				
POS	REFERENCE NUMBER	WALTH SKU	DESCRIPTION	PKG QTY
1	10.03.11.09.029 - 080800217	PR051037X	PRC-DOUBLE NOZZLE Ø 5.0 10PK	10
2		PR051037CX	PRC-DOUBLE NOZZLE Ø 5.0 CP 10PK	10

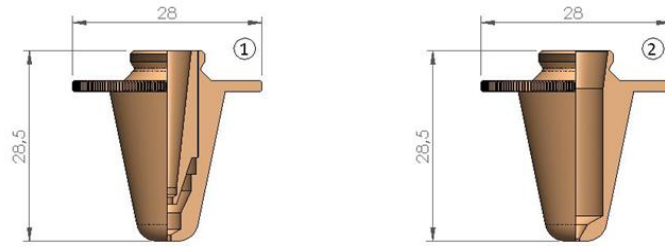

PRECITEC®

POS	REFERENCE NUMBER	WALTH SKU	DESCRIPTION	PKG QTY
1	080800198 - 693025	PR053027	PRC-DOUBLE NOZZLE Ø 1.5	1
	6930250682	PR053027V	PRC-DOUBLE NOZZLE Ø 1.5 5PK	5
	080800200 - 693025	PR053029	PRC-DOUBLE NOZZLE Ø 2.0	1
	6930250684	PR053029V	PRC-DOUBLE NOZZLE Ø 2.0 5PK	5
	080800202 - 693025	PR053031	PRC-DOUBLE NOZZLE Ø 2.5	1
	6930250686	PR053031V	PRC-DOUBLE NOZZLE Ø 2.5 5PK	5
	080800203 - 693025	PR053032	PRC-DOUBLE NOZZLE Ø 3.0	1
	6930250687	PR053032V	PRC-DOUBLE NOZZLE Ø 3.0 5PK	5
2	P0573-563-00015	PR053039	PRC-NOZZLE Ø 1.5	1
	P0573-563-00015	PR053039V	PRC-NOZZLE Ø 1.5 5PK	5
	P0573-564-00020	PR053041	PRC-NOZZLE Ø 2.0	1
	P0573-564-00020	PR053041V	PRC-NOZZLE Ø 2.0 5PK	5
	P0573-566-00025	PR053042	PRC-NOZZLE Ø 2.5	1
	P0573-566-00025	PR053042V	PRC-NOZZLE Ø 2.5 5PK	5
		PR053043	PRC-NOZZLE Ø 3.0	1
		PR053043V	PRC-NOZZLE Ø 3.0 5PK	5