

PRECITEC®

POS	REFERENCE NUMBER	WALTH SKU	DESCRIPTION	PKG QTY
1	281330 - P0571-260-00001 - 6930281330	PR059001	PRECITEC® ORIG NOZZLE HOLDER KT B2"	1
	P0571-260-00001	PR059004	PRC-NOZZLE HOLDER KT B2"	1
	P0571-1051-00001 - 6930281333 - 080800022	PR059002	PRECITEC® ORIG NZL HOLDER KT B2" CON	1
	P0571-1051-00001 - 6930281333 - 080800302	PR059003	PRC-NOZZLE HOLDER KT B2" CON	1
2	281590 - P0591-569-00008	PR051046X	PRC-NOZZLE Ø 0.8 10PK	10
	281331 - P0591-561-00010	PR051047X	PRC-NOZZLE Ø 1.0 10PK	10
	281351 - P0591-562-00012	PR051048X	PRC-NOZZLE Ø 1.2 10PK	10
	281352 - P0591-563-00015	PR051049X	PRC-NOZZLE Ø 1.5 10PK	10
		PR051050X	PRC-NOZZLE Ø 1.7 10PK	10
	281353 - P0591-564-00018	PR051051X	PRC-NOZZLE Ø 1.8 10PK	10
	281354 - P0591-565-00020	PR051052X	PRC-NOZZLE Ø 2.0 10PK	10
		PR051053X	PRC-NOZZLE Ø 2.3 10PK	10
	281591 - P0591-566-00025	PR051054X	PRC-NOZZLE Ø 2.5 10PK	10
		PR051055X	PRC-NOZZLE Ø 2.7 10PK	10
3		PR051056X	PRC-NOZZLE Ø 3.0 10PK	10
	281590 - P0591-569-00008	PR051046CX	PRC-NOZZLE Ø 0.8 CP 10PK	10
	281331 - P0591-561-00010	PR051047CX	PRC-NOZZLE Ø 1.0 CP 10PK	10
	281351 - P0591-562-00012	PR051048CX	PRC-NOZZLE Ø 1.2 CP 10PK	10
	281352 - P0591-563-00015	PR051049CX	PRC-NOZZLE Ø 1.5 CP 10PK	10
		PR051050CX	PRC-NOZZLE Ø 1.7 CP 10PK	10
	281353 - P0591-564-00018	PR051051CX	PRC-NOZZLE Ø 1.8 CP 10PK	10
	281354 - P0591-565-00020	PR051052CX	PRC-NOZZLE Ø 2.0 CP 10PK	10
		PR051053CX	PRC-NOZZLE Ø 2.3 CP 10PK	10
	281591 - P0591-566-00025	PR051054CX	PRC-NOZZLE Ø 2.5 CP 10PK	10
	PR051055CX	PRC-NOZZLE Ø 2.7 CP 10PK	10	
	PR051056CX	PRC-NOZZLE Ø 3.0 CP 10PK	10	

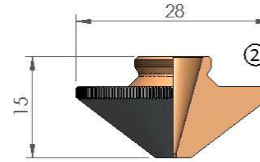
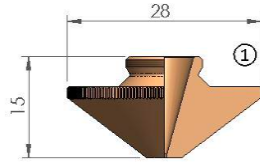

PRECITEC®

POS	REFERENCE NUMBER	WALTH SKU	DESCRIPTION	PKG QTY
1	P0591-673-00008	PR051002X	PRC-NOZZLE Ø 0.8 HD 10PK	10
	281548 - P0591-571-00010 - 29100233	PR051003X	PRC-NOZZLE Ø 1.0 HD 10PK	10
	281549 - P0591-572-00012 - 29100234	PR051004X	PRC-NOZZLE Ø 1.2 HD 10PK	10
		PR051005X	PRC-NOZZLE Ø 1.4 HD 10PK	10
	P0591-573-00015 - 281463 - 29100235 - 080800230	PR051006X	PRC-NOZZLE Ø 1.5 HD 10PK	10
	P0591-574-00018 - 29100236	PR051007X	PRC-NOZZLE Ø 1.8 HD 10PK	10
	10.03.11.09.011-281550-P0591-575-00020-29100237-080800231	PR051008X	PRC-NOZZLE Ø 2.0 HD 10PK	10
		PR051009X	PRC-NOZZLE Ø 2.3 HD 10PK	10
	10.03.11.09.012-281551-P0591-576-00025-29100239-080800232	PR051010X	PRC-NOZZLE Ø 2.5 HD 10PK	10
		PR051011X	PRC-NOZZLE Ø 2.75 HD 10PK	10
	P0591-577-00030	PR051012X	PRC-NOZZLE Ø 3.0HD10PK	10
		PR051013X	PRC-NOZZLE Ø 3.2 HD 10PK	10
	10.03.11.09.014 - 29100243-08	PR051014X	PRC-NOZZLE Ø 3.5 HD 10PK	10
		PR051015X	PRC-NOZZLE Ø 4.0 HD 10PK	10
		PR051016X	PRC-NOZZLE Ø 4.5 HD 10PK	10
		PR051017X	PRC-NOZZLE Ø 5.0 HD 10PK	10
		PR051019X	PRC-NOZZLE Ø 6.0 HD 10PK	10
2		PR051002CX	PRC-NOZZLE Ø 0.8 HD CP 10PK	10
	281548 - P0591-571-00010	PR051003CX	PRC-NOZZLE Ø 1.0 HD CP 10PK	10
	281549 - P0591-572-00012	PR051004CX	PRC-NOZZLE Ø 1.2 HD CP 10PK	10
		PR051005CX	PRC-NOZZLE Ø 1.4 HD CP 10PK	10
	281463 - P0591-573-00015	PR051006CX	PRC-NOZZLE Ø 1.5 HD CP 10PK	10
	P0591-574-00018	PR051007CX	PRC-NOZZLE Ø 1.8 HD CP 10PK	10
	281550 - P0591-575-00020	PR051008CX	PRC-NOZZLE Ø 2.0 HD CP 10PK	10
		PR051009CX	PRC-NOZZLE Ø 2.3 HD CP 10PK	10
	281551 - P0591-576-00025	PR051010CX	PRC-NOZZLE Ø 2.5 HD CP 10PK	10
		PR051011CX	PRC-NOZZLE Ø 2.75 HD CP 10PK	10
		PR051012CX	PRC-NOZZLE Ø 3.0 HD CP 10PK	10
		PR051013CX	PRC-NOZZLE Ø 3.2 HD CP 10PK	10
		PR051014CX	PRC-NOZZLE Ø 3.5 HD CP 10PK	10
		PR051015CX	PRC-NOZZLE Ø 4.0 HD CP 10PK	10
		PR051016CX	PRC-NOZZLE Ø 4.5 HD CP 10PK	10
		PR051017CX	PRC-NOZZLE Ø 5.0 HD CP 10PK	10
		PR051019CX	PRC-NOZZLE Ø 6.0 HD CP 10PK	10

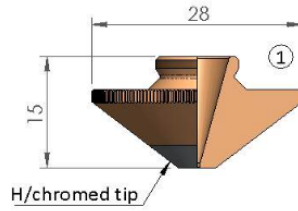

PRECITEC®				
POS	REFERENCE NUMBER	WALTH SKU	DESCRIPTION	PKG QTY
1		PR051002CK	PRC-NOZZLE Ø 0.8 HD CP	1
		PR051002CKX	PRC-NOZZLE Ø 0.8 HD CP 10PK	10
		PR051003CK	PRC-NOZZLE Ø 1.0 HD CP	1
		PR051003CKX	PRC-NOZZLE Ø 1.0 HD CP 10PK	10
		PR051004CK	PRC-NOZZLE Ø 1.2 HD CP	1
		PR051004CKX	PRC-NOZZLE Ø 1.2 HD CP 10PK	10
		PR051005CK	PRC-NOZZLE Ø 1.4 HD CP	1
		PR051005CKX	PRC-NOZZLE Ø 1.4 HD CP 10PK	10
		PR051006CK	PRC-NOZZLE Ø 1.5 HD CP	1
		PR051006CKX	PRC-NOZZLE Ø 1.5 HD CP 10PK	10
		PR051007CK	PRC-NOZZLE Ø 1.8 HD CP	1
		PR051007CKX	PRC-NOZZLE Ø 1.8 HD CP 10PK	10
		PR051008CK	PRC-NOZZLE Ø 2.0 HD CP	1
		PR051008CKX	PRC-NOZZLE Ø 2.0 HD CP 10PK	10
		PR051009CK	PRC-NOZZLE Ø 2.3 HD CP	1
		PR051009CKX	PRC-NOZZLE Ø 2.3 HD CP 10PK	10
		PR051010CK	PRC-NOZZLE Ø 2.5 HD CP	1
		PR051010CKX	PRC-NOZZLE Ø 2.5 HD CP 10PK	10
		PR051011CK	PRC-NOZZLE Ø 2.75 HD CP	1
		PR051011CKX	PRC-NOZZLE Ø 2.75 HD CP 10PK	10
		PR051012CK	PRC-NOZZLE Ø 3.0 HD CP	1
		PR051012CKX	PRC-NOZZLE Ø 3.0 HD CP 10PK	10
		PR051013CK	PRC-NOZZLE Ø 3.2 HD CP	1
		PR051013CKX	PRC-NOZZLE Ø 3.2 HD CP 10PK	10
		PR051014CK	PRC-NOZZLE Ø 3.5 HD CP	1
		PR051014CKX	PRC-NOZZLE Ø 3.5 HD CP 10PK	10
		PR051015CK	PRC-NOZZLE Ø 4.0 HD CP	1
		PR051015CKX	PRC-NOZZLE Ø 4.0 HD CP 10PK	10
		PR051016CK	PRC-NOZZLE Ø 4.5 HD CP	1
		PR051016CKX	PRC-NOZZLE Ø 4.5 HD CP 10PK	10
		PR051017CK	PRC-NOZZLE Ø 5.0 HD CP	1
		PR051017CKX	PRC-NOZZLE Ø 5.0 HD CP 10PK	10

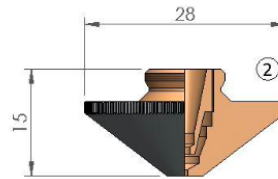
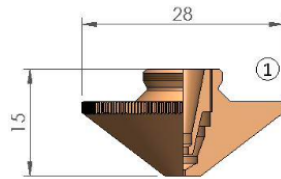

PRECITEC®

POS	REFERENCE NUMBER	WALTH SKU	DESCRIPTION	PKG QTY
1		PR051024X	PRC-DOUBLE NOZZLE Ø 0.8 10PK	10
	P0591-002-00010	PR051025X	PRC-DOUBLE NOZZLE Ø 1.0 10PK	10
	P0591-002-00012	PR051026X	PRC-DOUBLE NOZZLE Ø 1.2 10PK	10
		PR051027X	PRC-DOUBLE NOZZLE Ø 1.4 10PK	10
	P0591-002-00015	PR051028X	PRC-DOUBLE NOZZLE Ø 1.5 10PK	10
	10.03.11.09.031 - P0591-002- 00018	PR051029X	PRC-DOUBLE NOZZLE Ø 1.8 10PK	10
	P0591-002-00020	PR051030X	PRC-DOUBLE NOZZLE Ø 2.0 10PK	10
	P0591-002-00023	PR051031X	PRC-DOUBLE NOZZLE Ø 2.3 10PK	10
	P0591-002-00025	PR051032X	PRC-DOUBLE NOZZLE Ø 2.5 10PK	10
		PR051038X	PRC-DOUBLE NOZZLE Ø 2.7 10PK	10
	P0591-002-00030	PR051033X	PRC-DOUBLE NOZZLE Ø 3.0 10PK	10
	P0591-002-00035 - 29100384	PR051034X	PRC-DOUBLE NOZZLE Ø 3.5 10PK	10
	P0591-002-00040	PR051035X	PRC-DOUBLE NOZZLE Ø 4.0 10PK	10
		PR051036X	PRC-DOUBLE NOZZLE Ø 4.5 10PK	10
10.03.11.09.029 - 08000217	PR051037X	PRC-DOUBLE NOZZLE Ø 5.0 10PK	10	
2		PR051024CX	PRC-DOUBLE NOZZLE Ø 0.8 CP 10PK	10
		PR051025CX	PRC-DOUBLE NOZZLE Ø 1.0 CP 10PK	10
		PR051026CX	PRC-DOUBLE NOZZLE Ø 1.2 CP 10PK	10
		PR051027CX	PRC-DOUBLE NOZZLE Ø 1.4 CP 10PK	10
		PR051028CX	PRC-DOUBLE NOZZLE Ø 1.5 CP 10PK	10
		PR051029CX	PRC-DOUBLE NOZZLE Ø 1.8 CP 10PK	10
		PR051030CX	PRC-DOUBLE NOZZLE Ø 2.0 CP 10PK	10
		PR051031CX	PRC-DOUBLE NOZZLE Ø 2.3 CP 10PK	10
		PR051032CX	PRC-DOUBLE NOZZLE Ø 2.5 CP 10PK	10
		PR051038CX	PRC-DOUBLE NOZZLE Ø 2.7 CP 10PK	10
		PR051033CX	PRC-DOUBLE NOZZLE Ø 3.0 CP 10PK	10
		PR051034CX	PRC-DOUBLE NOZZLE Ø 3.5 CP 10PK	10
		PR051035CX	PRC-DOUBLE NOZZLE Ø 4.0 CP 10PK	10
		PR051036CX	PRC-DOUBLE NOZZLE Ø 4.5 CP 10PK	10
	PR051037CX	PRC-DOUBLE NOZZLE Ø 5.0 CP 10PK	10	

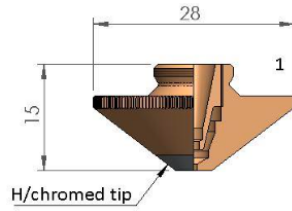

PRECITEC®				
POS	REFERENCE NUMBER	WALTH SKU	DESCRIPTION	PKG QTY
1		PR051024CK	PRC-DOUBLE NOZZLE Ø 0.8 CP	1
		PR051024CKX	PRC-DOUBLE NOZZLE Ø 0.8 CP 10PK	10
		PR051025CK	PRC-DOUBLE NOZZLE Ø 1.0 CP	1
		PR051025CKX	PRC-DOUBLE NOZZLE Ø 1.0 CP 10PK	10
		PR051026CK	PRC-DOUBLE NOZZLE Ø 1.2 CP	1
		PR051026CKX	PRC-DOUBLE NOZZLE Ø 1.2 CP 10PK	10
		PR051027CK	PRC-DOUBLE NOZZLE Ø 1.4 CP	1
		PR051027CKX	PRC-DOUBLE NOZZLE Ø 1.4 CP 10PK	10
		PR051028CK	PRC-DOUBLE NOZZLE Ø 1.5 CP	1
		PR051028CKX	PRC-DOUBLE NOZZLE Ø 1.5 CP 10PK	10
		PR051029CK	PRC-DOUBLE NOZZLE Ø 1.8 CP	1
		PR051029CKX	PRC-DOUBLE NOZZLE Ø 1.8 CP 10PK	10
		PR051030CK	PRC-DOUBLE NOZZLE Ø 2.0 CP	1
		PR051030CKX	PRC-DOUBLE NOZZLE Ø 2.0 CP 10PK	10
		PR051031CK	PRC-DOUBLE NOZZLE Ø 2.3 CP	1
		PR051031CKX	PRC-DOUBLE NOZZLE Ø 2.3 CP 10PK	10
		PR051032CK	PRC-DOUBLE NOZZLE Ø 2.5 CP	1
		PR051032CKX	PRC-DOUBLE NOZZLE Ø 2.5 CP 10PK	10
		PR051038CK	PRC-DOUBLE NOZZLE Ø 2.7 CP	1
		PR051038CKX	PRC-DOUBLE NOZZLE Ø 2.7 CP 10PK	10
		PR051033CK	PRC-DOUBLE NOZZLE Ø 3.0 CP	1
		PR051033CKX	PRC-DOUBLE NOZZLE Ø 3.0 CP 10PK	10
		PR051034CK	PRC-DOUBLE NOZZLE Ø 3.5 CP	1
		PR051034CKX	PRC-DOUBLE NOZZLE Ø 3.5 CP 10PK	10
		PR051035CK	PRC-DOUBLE NOZZLE Ø 4.0 CP	1
		PR051035CKX	PRC-DOUBLE NOZZLE Ø 4.0 CP 10PK	10
		PR051036CK	PRC-DOUBLE NOZZLE Ø 4.5 CP	1
		PR051036CKX	PRC-DOUBLE NOZZLE Ø 4.5 CP 10PK	10
		PR051037CK	PRC-DOUBLE NOZZLE Ø 5.0 CP	1
		PR051037CKX	PRC-DOUBLE NOZZLE Ø 5.0 CP 10PK	10

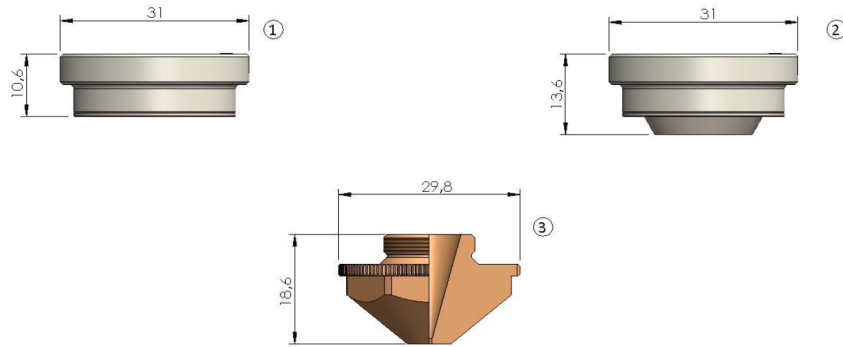

PRECITEC®				
POS	REFERENCE NUMBER	WALTH SKU	DESCRIPTION	PKG QTY
1	P0595-92036	PR059023	PRECITEC® ORIGINAL NOZZLE HLDR KT X	1
	P0595-92036	PR059027	PRC-NOZZLE HOLDER KT X	1
2	P0595-94097	PR059024	PRECITEC® ORIGINAL NOZZLE HLDR KT XB	1
	P0595-94097	PR059028	PRC-NOZZLE HOLDER KT XB	1
3	P0595-94263	PR057002X	PRC-NOZZLE KT X Ø 1.0 10PK	10
	P0595-92688	PR057003X	PRC-NOZZLE KT X Ø 1.2 10PK	10
	P0595-92733	PR057004X	PRC-NOZZLE KT X Ø 1.5 10PK	10
	P0595-92733	PR057005X	PRC-NOZZLE KT X Ø 1.7 10PK	10
	P0595-92735	PR057006X	PRC-NOZZLE KT X Ø 2.0 10PK	10
	P0595-92736	PR057007X	PRC-NOZZLE KT X Ø 2.2 10PK	10
	P0595-92737	PR057008X	PRC-NOZZLE KT X Ø 3.0 10PK	10
	P0595-92738	PR057009X	PRC-NOZZLE KT X Ø 3.5 10PK	10
	P0595-92739	PR057010X	PRC-NOZZLE KT X Ø 4.0 10PK	10
	P0595-92741	PR057012X	PRC-NOZZLE KT X Ø 5.0 10PK	10

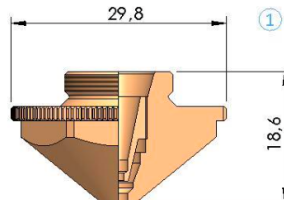

PRECITEC®				
POS	REFERENCE NUMBER	WALTH SKU	DESCRIPTION	PKG QTY
1	P0595-92868	PR057021X	PRC-DOUBLE NOZZLE KT X Ø 0.8 10PK	10
	P0595-92871	PR057022X	PRC-DOUBLE NOZZLE KT X Ø 1.0 10PK	10
	P0595-92879	PR057023X	PRC-DOUBLE NOZZLE KT X Ø 1.2 10PK	10
	P0595-92881	PR057024X	PRC-DOUBLE NOZZLE KT X Ø 1.4 10PK	10
	P0595-92883	PR057025X	PRC-DOUBLE NOZZLE KT X Ø 1.5 10PK	10
	P0595-92886	PR057026X	PRC-DOUBLE NOZZLE KT X Ø 1.8 10PK	10
	P0595-92901	PR057027X	PRC-DOUBLE NOZZLE KT X Ø 2.0 10PK	10
	P0595-92904	PR057028X	PRC-DOUBLE NOZZLE KT X Ø 2.3 10PK	10
	P0595-92906	PR057029X	PRC-DOUBLE NOZZLE KT X Ø 2.5 10PK	10
	P0595-92909	PR057030X	PRC-DOUBLE NOZZLE KT X Ø 3.0 10PK	10
	P0595-92911	PR057031X	PRC-DOUBLE NOZZLE KT X Ø 3.5 10PK	10
	P0595-92913	PR057032X	PRC-DOUBLE NOZZLE KT X Ø 4.0 10PK	10
	P0595-92915	PR057033X	PRC-DOUBLE NOZZLE KT X Ø 4.5 10PK	10
	P0595-92917	PR057034X	PRC-DOUBLE NOZZLE KT X Ø 5.0 10PK	10

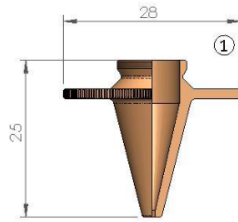

PRECITEC®				
POS	REFERENCE NUMBER	WALTH SKU	DESCRIPTION	PKG QTY
1		PR053008	PRC-NOZZLE LONG Ø 1.0	1
		PR053009	PRC-NOZZLE LONG Ø 1.5	1
		PR053010	PRC-NOZZLE LONG Ø 1.8	1
		PR053011	PRC-NOZZLE LONG Ø 2.0	1

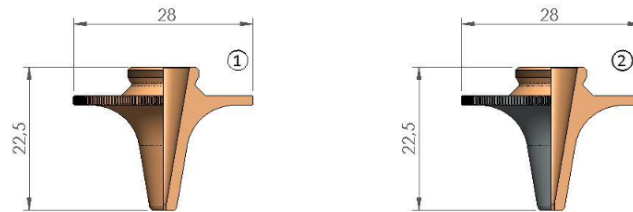

PRECITEC®				
POS	REFERENCE NUMBER	WALTH SKU	DESCRIPTION	PKG QTY
1	P0578-0411-00010	PR053002	PRC-NOZZLE RADIUS LONG Ø 1.0	1
	P0578-0412-00012	PR053003	PRC-NOZZLE RADIUS LONG Ø 1.2	1
	P0578-0413-00015 - 6930300039	PR053004	PRC-NOZZLE RADIUS LONG Ø 1.5	1
	P0578-0414-00018	PR053005	PRC-NOZZLE RADIUS LONG Ø 1.8	1
	P0578-0415-00020 - 6930300040	PR053006	PRC-NOZZLE RADIUS LONG Ø 2.0	1
	P0578-0417-00025	PR053007	PRC-NOZZLE RADIUS LONG Ø 2.5	1
2		PR053002C	PRC-NOZZLE RADIUS LONG Ø 1.0 CP	1
		PR053003C	PRC-NOZZLE RADIUS LONG Ø 1.2 CP	1
		PR053004C	PRC-NOZZLE RADIUS LONG Ø 1.5 CP	1
		PR053005C	PRC-NOZZLE RADIUS LONG Ø 1.8 CP	1
		PR053006C	PRC-NOZZLE RADIUS LONG Ø 2.0 CP	1
		PR053007C	PRC-NOZZLE RADIUS LONG Ø 2.5 CP	1

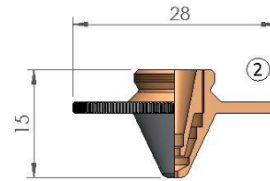
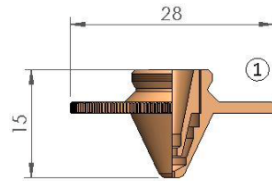

PRECITEC®

POS	REFERENCE NUMBER	WALTH SKU	DESCRIPTION	PKG QTY
1	6930250001	PR051060X	PRC-DOUBLE NOZZLE Ø 0.8 10PK	10
	6930250002	PR051061X	PRC-DOUBLE NOZZLE Ø 1.0 10PK	10
	6930250003	PR051062X	PRC-DOUBLE NOZZLE Ø 1.2 10PK	10
	6930250004	PR051063X	PRC-DOUBLE NOZZLE Ø 1.5 10PK	10
		PR051064X	PRC-DOUBLE NOZZLE Ø 1.8 10PK	10
2		PR051060CX	PRC-DOUBLE NOZZLE Ø 0.8 CP 10PK	10
		PR051061CX	PRC-DOUBLE NOZZLE Ø 1.0 CP 10PK	10
		PR051062CX	PRC-DOUBLE NOZZLE Ø 1.2 CP 10PK	10
		PR051063CX	PRC-DOUBLE NOZZLE Ø 1.5 CP 10PK	10
		PR051064CX	PRC-DOUBLE NOZZLE Ø 1.8 CP 10PK	10

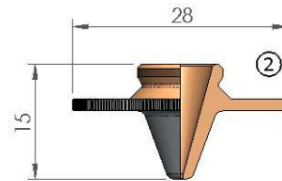
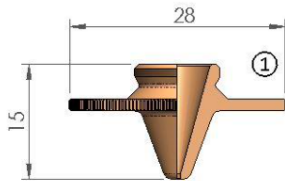

PRECITEC®

POS	REFERENCE NUMBER	WALTH SKU	DESCRIPTION	PKG QTY
1		PR051070X	PRC-NOZZLE Ø 0.8 10PK	10
		PR051071X	PRC-NOZZLE Ø 1.0 10PK	10
		PR051072X	PRC-NOZZLE Ø 1.2 10PK	10
		PR051073X	PRC-NOZZLE Ø 1.5 10PK	10
2		PR051070CX	PRC-NOZZLE Ø 0.8 CP 10PK	10
		PR051071CX	PRC-NOZZLE Ø 1.0 CP 10PK	10
		PR051072CX	PRC-NOZZLE Ø 1.2 CP 10PK	10
		PR051073CX	PRC-NOZZLE Ø 1.5 CP 10PK	10

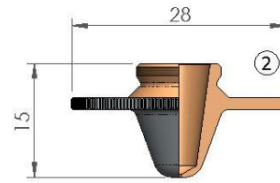
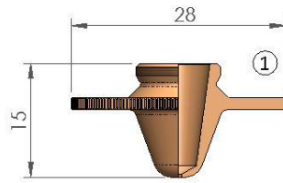

PRECITEC®

POS	REFERENCE NUMBER	WALTH SKU	DESCRIPTION	PKG QTY
1		PR051080X	PRC-NOZZLE Ø 0.8 10PK	10
		PR051081X	PRC-NOZZLE Ø 1.0 10PK	10
		PR051082X	PRC-NOZZLE Ø 1.2 10PK	10
	P0591-1049-00015	PR051083X	PRC-NOZZLE Ø 1.5 10PK	10
	P0591-1050-00018	PR051084X	PRC-NOZZLE Ø 1.8 10PK	10
		PR051085X	PRC-NOZZLE Ø 2.0 10PK	10
2		PR051080CX	PRC-NOZZLE Ø 0.8 CP 10PK	10
		PR051081CX	PRC-NOZZLE Ø 1.0 CP 10PK	10
		PR051082CX	PRC-NOZZLE Ø 1.2 CP 10PK	10
		PR051083CX	PRC-NOZZLE Ø 1.5 CP 10PK	10
		PR051084CX	PRC-NOZZLE Ø 1.8 CP 10PK	10
		PR051085CX	PRC-NOZZLE Ø 2.0 CP 10PK	10

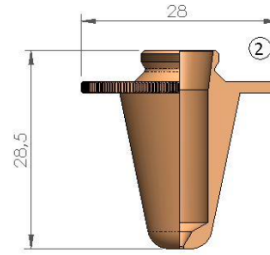
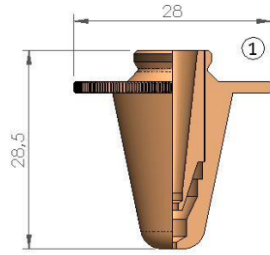

PRECITEC®

POS	REFERENCE NUMBER	WALTH SKU	DESCRIPTION	PKG QTY	
1	6930250680	PR053025	PRC-DOUBLE NOZZLE Ø 1.0	1	
	6930250680	PR053025V	PRC-DOUBLE NOZZLE Ø 1.0 5PK	5	
	6930250681	PR053026	PRC-DOUBLE NOZZLE Ø 1.2	1	
	6930250681	PR053026V	PRC-DOUBLE NOZZLE Ø 1.2 5PK	5	
	080800198 - 693025	PR053027	PRC-DOUBLE NOZZLE Ø 1.5	1	
	6930250682	PR053027V	PRC-DOUBLE NOZZLE Ø 1.5 5PK	5	
	6930250683	PR053028	PRC-DOUBLE NOZZLE Ø 1.8	1	
	6930250683	PR053028V	PRC-DOUBLE NOZZLE Ø 1.8 5PK	5	
	080800200 - 693025	PR053029	PRC-DOUBLE NOZZLE Ø 2.0	1	
	6930250684	PR053029V	PRC-DOUBLE NOZZLE Ø 2.0 5PK	5	
		PR053030	PRC-DOUBLE NOZZLE Ø 2.3	1	
		PR053030V	PRC-DOUBLE NOZZLE Ø 2.3 5PK	5	
		080800202 - 693025	PR053031	PRC-DOUBLE NOZZLE Ø 2.5	1
		6930250686	PR053031V	PRC-DOUBLE NOZZLE Ø 2.5 5PK	5
		080800203 - 693025	PR053032	PRC-DOUBLE NOZZLE Ø 3.0	1
		6930250687	PR053032V	PRC-DOUBLE NOZZLE Ø 3.0 5PK	5
	6930250688	PR053033	PRC-DOUBLE NOZZLE Ø 3.5	1	
	6930250688	PR053033V	PRC-DOUBLE NOZZLE Ø 3.5 5PK	5	
2	P0573-563-00010	PR053037	PRC-NOZZLE Ø 1.0	1	
	P0573-563-00010	PR053037V	PRC-NOZZLE Ø 1.0 5PK	5	
	P0573-563-00012	PR053038	PRC-NOZZLE Ø 1.2	1	
	P0573-563-00012	PR053038V	PRC-NOZZLE Ø 1.2 5PK	5	
	P0573-563-00015	PR053039	PRC-NOZZLE Ø 1.5	1	
	P0573-563-00015	PR053039V	PRC-NOZZLE Ø 1.5 5PK	5	
		PR053040	PRC-NOZZLE Ø 1.8	1	
		PR053040V	PRC-NOZZLE Ø 1.8 5PK	5	
		P0573-564-00020	PR053041	PRC-NOZZLE Ø 2.0	1
		P0573-564-00020	PR053041V	PRC-NOZZLE Ø 2.0 5PK	5
		P0573-566-00025	PR053042	PRC-NOZZLE Ø 2.5	1
		P0573-566-00025	PR053042V	PRC-NOZZLE Ø 2.5 5PK	5
		PR053043	PRC-NOZZLE Ø 3.0	1	
		PR053043V	PRC-NOZZLE Ø 3.0 5PK	5	

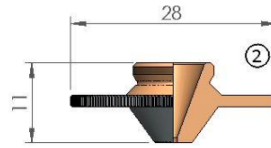
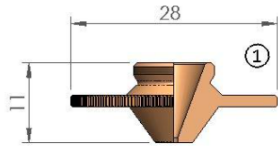

PRECITEC®

POS	REFERENCE NUMBER	WALTH SKU	DESCRIPTION	PKG QTY
1		PR052020X	PRC-NOZZLE Ø 1.0 HD 10PK	10
		PR052021X	PRC-NOZZLE Ø 1.2 HD 10PK	10
		PR052022X	PRC-NOZZLE Ø 1.5 HD 10PK	10
		PR052023X	PRC-NOZZLE Ø 2.0 HD 10PK	10
		PR052024X	PRC-NOZZLE Ø 2.5 HD 10PK	10
		PR052025X	PRC-NOZZLE Ø 3.0 HD 10PK	10
		PR052026X	PRC-NOZZLE Ø 3.5 HD 10PK	10
		PR052027X	PRC-NOZZLE Ø 4.0 HD 10PK	10
		PR052028X	PRC-NOZZLE Ø 4.5 HD 10PK	10
		PR052029X	PRC-NOZZLE Ø 5.0 HD 10PK	10
2		PR052020CX	PRC-NOZZLE Ø 1.0 HD CP 10PK	10
		PR052021CX	PRC-NOZZLE Ø 1.2 HD CP 10PK	10
		PR052022CX	PRC-NOZZLE Ø 1.5 HD CP 10PK	10
		PR052023CX	PRC-NOZZLE Ø 2.0 HD CP 10PK	10
		PR052024CX	PRC-NOZZLE Ø 2.5 HD CP 10PK	10
		PR052025CX	PRC-NOZZLE Ø 3.0 HD CP 10PK	10
		PR052026CX	PRC-NOZZLE Ø 3.5 HD CP 10PK	10
		PR052027CX	PRC-NOZZLE Ø 4.0 HD CP 10PK	10
		PR052028CX	PRC-NOZZLE Ø 4.0 HD CP 10PK	10
		PR052029CX	PRC-NOZZLE Ø 5.0 HD CP 10PK	10

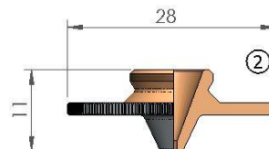
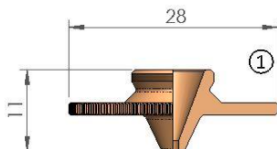

PRECITEC®

POS	REFERENCE NUMBER	WALTH SKU	DESCRIPTION	PKG QTY
1		PR052014X	PRC-NOZZLE Ø 1.5 HD 10PK	10
		PR052015X	PRC-NOZZLE Ø 2.0 HD 10PK	10
		PR052016X	PRC-NOZZLE Ø 2.5 HD 10PK	10
2		PR052014CX	PRC-NOZZLE Ø 1.5 HD CP 10PK	10
		PR052015CX	PRC-NOZZLE Ø 2.0 HD CP 10PK	10
		PR052016CX	PRC-NOZZLE Ø 2.5 HD CP 10PK	10

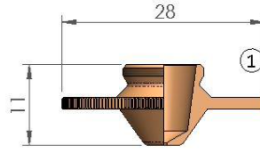

PRECITEC®				
POS	REFERENCE NUMBER	WALTH SKU	DESCRIPTION	PKG QTY
1	281340 - P0571-281-00010	PR052032X	PRC-NOZZLE Ø 1.0 10PK	10
	281341 - P0571-282-00012	PR052033X	PRC-NOZZLE Ø 1.2 10PK	10
	281342 - P0571-283-00015	PR052034X	PRC-NOZZLE Ø 1.5 10PK	10
2	281342 - P0571-284-00018	PR052035X	PRC-NOZZLE Ø 1.8 10PK	10
	281343 - P0571-285-00020	PR052036X	PRC-NOZZLE Ø 2.0 10PK	10
	281344 - P0571-286-00025	PR052037X	PRC-NOZZLE Ø 2.5 10PK	10

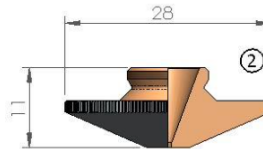
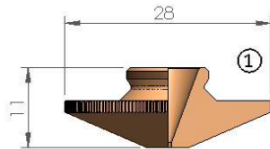

PRECITEC®				
POS	REFERENCE NUMBER	WALTH SKU	DESCRIPTION	PKG QTY
1	281559 - P0571-291-00010	PR052040X	PRC-NOZZLE Ø 1.0 10PK	10
	P0571-292-00012	PR052041X	PRC-NOZZLE Ø 1.2 10PK	10
	281570 - P0571-293-00015	PR052042X	PRC-NOZZLE Ø 1.5 10PK	10
		PR052043X	PRC-NOZZLE Ø 1.8 10PK	10
	281571 - P0571-295-00020	PR052044X	PRC-NOZZLE Ø 2.0 10PK	10
	281572 - P0571-297-00025	PR052045X	PRC-NOZZLE Ø 2.5 10PK	10
2		PR052046X	PRC-NOZZLE Ø 3.0 10PK	10
		PR052040CX	PRC-NOZZLE Ø 1.0 CP 10PK	10
		PR052041CX	PRC-NOZZLE Ø 1.2 CP 10PK	10
		PR052042CX	PRC-NOZZLE Ø 1.5 CP 10PK	10
		PR052043CX	PRC-NOZZLE Ø 1.8 CP 10PK	10
		PR052044CX	PRC-NOZZLE Ø 2.0 CP 10PK	10
	PR052045CX	PRC-NOZZLE Ø 2.5 CP 10PK	10	
	PR052046CX	PRC-NOZZLE Ø 3.0 CP 10PK	10	

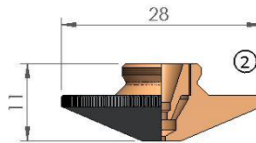
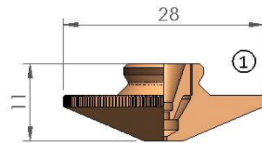

PRECITEC®

POS	REFERENCE NUMBER	WALTH SKU	DESCRIPTION	PKG QTY
1		PR052002X	PRC-DOUBLE NOZZLE Ø 1.0 10PK	10
		PR052003X	PRC-DOUBLE NOZZLE Ø 1.2 10PK	10
		PR052004X	PRC-DOUBLE NOZZLE Ø 1.4 10PK	10
		PR052005X	PRC-DOUBLE NOZZLE Ø 1.5 10PK	10
		PR052006X	PRC-DOUBLE NOZZLE Ø 1.8 10PK	10
		PR052007X	PRC-DOUBLE NOZZLE Ø 2.0 10PK	10
		PR052008X	PRC-DOUBLE NOZZLE Ø 2.5 10PK	10
		PR052009X	PRC-DOUBLE NOZZLE Ø 3.0 10PK	10
		PR052010X	PRC-DOUBLE NOZZLE Ø 3.5 10PK	10
	2		PR052002CX	PRC-DOUBLE NOZZLE Ø 1.0 CP 10PK
		PR052003CX	PRC-DOUBLE NOZZLE Ø 1.2 CP 10PK	10
		PR052004CX	PRC-DOUBLE NOZZLE Ø 1.4 CP 10PK	10
		PR052005CX	PRC-DOUBLE NOZZLE Ø 1.5 CP 10PK	10
		PR052006CX	PRC-DOUBLE NOZZLE Ø 1.8 CP 10PK	10
		PR052007CX	PRC-DOUBLE NOZZLE Ø 2.0 CP 10PK	10
		PR052008CX	PRC-DOUBLE NOZZLE Ø 2.5 CP 10PK	10
		PR052009CX	PRC-DOUBLE NOZZLE Ø 3.0 CP 10PK	10
		PR052010CX	PRC-DOUBLE NOZZLE Ø 3.5 CP 10PK	10

WALTH

®

Replacement parts suitable for:
PRECITEC®

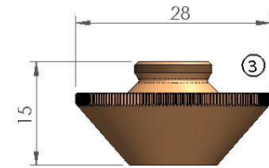
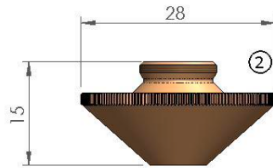
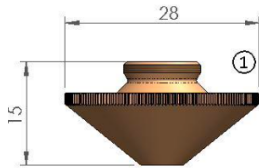

PRECITEC®

POS	REFERENCE NUMBER	WALTH SKU	DESCRIPTION	PKG QTY
1		PR056001	PRC-DOUBLE NOZZLE Ø 2.5 - SS	1
		PR056002	PRC-DOUBLE NOZZLE Ø 3.0 - SS	1
		PR056003	PRC-DOUBLE NOZZLE Ø 4.0 - SS	1
2		PR056004	PRC-DOUBLE NOZZLE Ø 6.0 - SS	1
3		PR056005	PRC-DOUBLE NOZZLE Ø 10.0 - SS	1

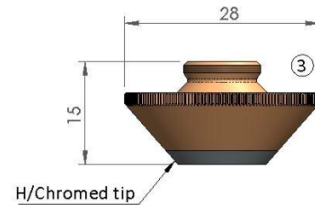
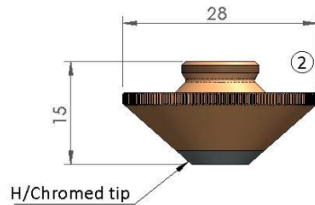
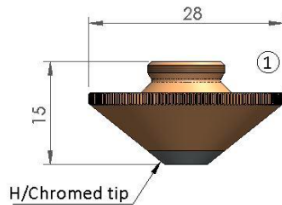

PRECITEC®

POS	REFERENCE NUMBER	WALTH SKU	DESCRIPTION	PKG QTY
1		PR056001CK	PRC-DOUBLE NOZZLE Ø 2.5 CP - SS	1
		PR056002CK	PRC-DOUBLE NOZZLE Ø 3.0 CP - SS	1
		PR056003CK	PRC-DOUBLE NOZZLE Ø 4.0 CP - SS	1
2		PR056004CK	PRC-DOUBLE NOZZLE Ø 6.0 CP - SS	1
3		PR056005CK	PRC-DOUBLE NOZZLE Ø 10.0 CP - SS	1

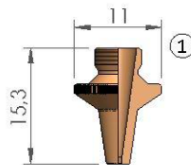

PRECITEC®

POS	REFERENCE NUMBER	WALTH SKU	DESCRIPTION	PKG QTY
1		PR054025X	PRC-NOZZLE Ø 1.0 10PK	10
	P0787-483-00012	PR054026X	PRC-NOZZLE Ø 1.2 10PK	10
	P0787-483-00015	PR054027X	PRC-NOZZLE Ø 1.5 10PK	10
		PR054028X	PRC-NOZZLE Ø 1.7 10PK	10
	P0787-1001-00020	PR054029X	PRC-NOZZLE Ø 2.0 10PK	10
		PR054030X	PRC-NOZZLE Ø 2.5 10PK	10

Walth Corporation is not affiliated with the named manufacturers. Reference to machines, parts, descriptions, and model numbers are for convenience in verifying compatibility only. All parts are made by or for Walth Corporation and are not made by the reference manufacturers (unless expressly indicated). All other trademarks are the properties of their respective owners.

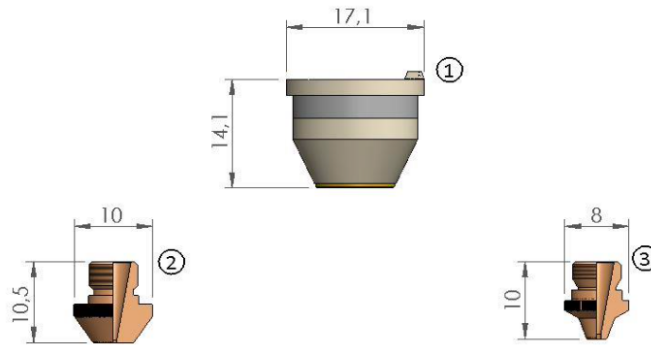

PRECITEC®				
POS	REFERENCE NUMBER	WALTH SKU	DESCRIPTION	PKG QTY
1	280408 - P0494-752-00001 - 092405	PR059010	PRECITEC® ORIG NZL HLD KT M1.5" KN	1
	P0494-110602	PR059013	PRECITEC® ORIGINAL NZL HLD KT KN III	1
2		PR054002X	PRC-NOZZLE Ø 0.8 10PK	10
	280551 - P0494-853-00010	PR054003X	PRC-NOZZLE Ø 1.0 10PK	10
	280552 - P0494-854-00012	PR054004X	PRC-NOZZLE Ø 1.2 10PK	10
	280553 - P0494-855-00015	PR054005X	PRC-NOZZLE Ø 1.5 10PK	10
	280554 - P0494-856-00017	PR054006X	PRC-NOZZLE Ø 1.7 10PK	10
		PR054012X	PRC-NOZZLE Ø 1.8 10PK	10
	280555 - P0494-857-00020	PR054007X	PRC-NOZZLE Ø 2.0 10PK	10
		PR054008X	PRC-NOZZLE Ø 2.3 10PK	10
		PR054009X	PRC-NOZZLE Ø 2.5 10PK	10
		PR054013X	PRC-NOZZLE Ø 2.7 10PK	10
		PR054010X	PRC-NOZZLE Ø 3.0 10PK	10
		PR054011X	PRC-NOZZLE Ø 4.0 10PK	10
3	280943 - P0494-787-00010	PR054016X	PRC-NOZZLE Ø 1.0 10PK	10
	280942 - P0494-788-00012	PR054017X	PRC-NOZZLE Ø 1.2 10PK	10
	280941 - P0494-789-00015	PR054018X	PRC-NOZZLE Ø 1.5 10PK	10
		PR054019X	PRC-NOZZLE Ø 1.8 10PK	10
		PR054020X	PRC-NOZZLE Ø 2.0 10PK	10



PRECITEC®				
POS	REFERENCE NUMBER	WALTH SKU	DESCRIPTION	PKG QTY
1	281813 - P0589-424-00008	PR055014X	PRC-NOZZLE Ø 0.8 10PK	10
	281789 - P0589-426-00010	PR055015X	PRC-NOZZLE Ø 1.0 10PK	10
	281561 - 778550	PR055016X	PRC-NOZZLE Ø 1.2 10PK	10
	281814 - 149957	PR055017X	PRC-NOZZLE Ø 1.5 10PK	10
	P0589-428-00020	PR055018X	PRC-NOZZLE Ø 2.0 10PK	10
2	281813 - P0589-424-00008	PR055014CX	PRC-NOZZLE Ø 0.8 CP 10PK	10
	281789 - P0589-426-00010	PR055015CX	PRC-NOZZLE Ø 1.0 CP 10PK	10
	281561 - 778550	PR055016CX	PRC-NOZZLE Ø 1.2 CP 10PK	10
	281814 - 149957	PR055017CX	PRC-NOZZLE Ø 1.5 CP 10PK	10
	P0589-428-00020	PR055018CX	PRC-NOZZLE Ø 2.0 CP 10PK	10

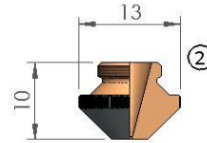
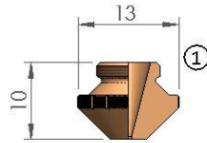

PRECITEC®				
POS	REFERENCE NUMBER	WALTH SKU	DESCRIPTION	PKG QTY
1	280013 - P0492-441-00008 - W222	PR055020X	PRC-NOZZLE Ø 0.8 10PK	10
	280014 - P0492-442-00010 - W223	PR055021X	PRC-NOZZLE Ø 1.0 10PK	10
	280015 - P0492-443-00012 - W228	PR055022X	PRC-NOZZLE Ø 1.2 10PK	10
	280016 - P0492-444-00015 - W224	PR055023X	PRC-NOZZLE Ø 1.5 10PK	10
2	P0492-447-00018	PR055024X	PRC-NOZZLE Ø 1.8 10PK	10
	280937 - P0492-445-00020 - W225	PR055025X	PRC-NOZZLE Ø 2.0 10PK	10
	P0492-448-00023	PR055026X	PRC-NOZZLE Ø 2.3 10PK	10
	281791 - P0492-446-00025 - W226	PR055027X	PRC-NOZZLE Ø 2,5 10PK	10
		PR055028X	PRC-NOZZLE Ø 3.0 10PK	10
	280013 - P0492-441-00008 - W222	PR055020CX	PRC-NOZZLE Ø 0.8 CP 10PK	10
	280014 - P0492-442-00010 - W223	PR055021CX	PRC-NOZZLE Ø 1.0 CP 10PK	10
	280015 - P0492-443-00012 - W228	PR055022CX	PRC-NOZZLE Ø 1.2 CP 10PK	10
	280016 - P0492-444-00015 - W224	PR055023CX	PRC-NOZZLE Ø 1.5 CP 10PK	10
	P0492-447-00018	PR055024CX	PRC-NOZZLE Ø 1.8 CP 10PK	10
	280937 - P0492-445-00020 - W225	PR055025CX	PRC-NOZZLE Ø 2.0 CP 10PK	10
	P0492-448-00023	PR055026CX	PRC-NOZZLE Ø 2.3 CP 10PK	10
3	281791 - P0492-446-00025 - W226	PR055027CX	PRC-NOZZLE Ø 2,5 CP 10PK	10
		PR055028CX	PRC-NOZZLE Ø 3.0 CP 10PK	10

PRECITEC®				
POS	REFERENCE NUMBER	WALTH SKU	DESCRIPTION	PKG QTY
	P0360-240-20000	PR059030	PRECITEC® ORG SNR CBL KS 20M GW Z PU	1
	P0360-210-00600	PR059031	PRC-ELECTRODE CABLE 600MM GW	1
	P0360-600-00320	PR059032	PRECITEC® ORIGINAL CABLE KE 320 GG	1
	P0360-100-00500	PR059033	PRECITEC® ORG ETR CABLE 500MM GG Z	1
	P0360-156-00200	PR059034	PRECITEC® ORIG SENSOR CABLE 200MM	1
	P0492-001-00130	PR059035	PRECITEC® ORG SENSOR CABLE KE 130 GW	1
		PR059036	PRECITEC® ORG ELECTRODE CBL 220GG MM	1
	P0492-014-00300	PR059037	PRECITEC® ORG SNR CBL KE 300 GW MH	1