

PRECITEC® / TRUMPF®

POS	REFERENCE NUMBER	WALTH SKU	DESCRIPTION	PKG QTY
1	280408 - P0494-752-00001 - 092405 - 6930300016	PR059010	PRECITEC® ORIG NZL HLD KT M1,5" KN	1
	P0494-110602	PR059013	PRECITEC® ORIG NZL HLD KT KN III	1
2	0936678 - 913966/00-WO	TR019004	TRM-CERAMIC NOZZLE HOLDER	1
3	135420 - 1354230	TR013040X	TRM-NOZZLE Ø 0.8 10PK	10
	212334	TR013041X	TRM-NOZZLE Ø 1.0 10PK	10
4	135420 - 1354230	TR013040CX	TRM-NOZZLE Ø 0.8 CP 10PK	10
	212334	TR013041CX	TRM-NOZZLE Ø 1.0 CP 10PK	10
5		TR013030X	TRM-NOZZLE Ø 0.8 HD 10PK	10
		TR013031X	TRM-NOZZLE Ø 1.0 HD 10PK	10
	1479581	TR013032X	TRM-NOZZLE Ø 1.2 HD 10PK	10
	216199	TR013033X	TRM-NOZZLE Ø 1.4 HD 10PK	10
	225213	TR013034X	TRM-NOZZLE Ø 1.7 HD 10PK	10
	1487009	TR013035X	TRM-NOZZLE Ø 2.0 HD 10PK	10
	126156	TR013036X	TRM-NOZZLE Ø 2.3 HD 10PK	10
		TR013037X	TRM-NOZZLE Ø 2.5 HD 10PK	10
6		TR013038X	TRM-NOZZLE Ø 2.7 HD 10PK	10
		TR013030CX	TRM-NOZZLE Ø 0.8 HD CP 10PK	10
		TR013031CX	TRM-NOZZLE Ø 1.0 HD CP 10PK	10
	1479581	TR013032CX	TRM-NOZZLE Ø 1.2 HD CP 10PK	10
	216199	TR013033CX	TRM-NOZZLE Ø 1.4 HD CP 10PK	10
	225213	TR013034CX	TRM-NOZZLE Ø 1.7 HD CP 10PK	10
	1487009	TR013035CX	TRM-NOZZLE Ø 2.0 HD CP 10PK	10
	126156	TR013036CX	TRM-NOZZLE Ø 2.3 HD CP 10PK	10
7		TR013037CX	TRM-NOZZLE Ø 2.5 HD CP 10PK	10
		TR013038CX	TRM-NOZZLE Ø 2.7 HD CP 10PK	10
7	913965	TR019005	TRM-RETAINER NUT	1

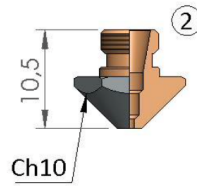

TRUMPF®				
POS	REFERENCE NUMBER	WALTH SKU	DESCRIPTION	PKG QTY
1	226939	TR013065X	TRM-NOZZLE Ø 1.0 10PK	10
	226940	TR013066X	TRM-NOZZLE Ø 1.4 10PK	10
	226941	TR013067X	TRM-NOZZLE Ø 1.7 10PK	10
2	226939	TR013065CX	TRM-NOZZLE Ø 1.0 CP 10PK	10
	226940	TR013066CX	TRM-NOZZLE Ø 1.4 CP 10PK	10
	226941	TR013067CX	TRM-NOZZLE Ø 1.7 CP 10PK	10

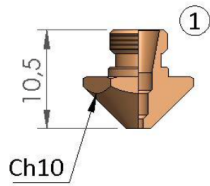
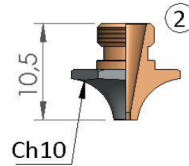
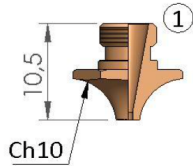

TRUMPF®				
POS	REFERENCE NUMBER	WALTH SKU	DESCRIPTION	PKG QTY
1		TR013055X	TRM-NOZZLE Ø 1.0 HD 10PK	10
		TR013056X	TRM-NOZZLE Ø 1.4 HD 10PK	10
		TR013057X	TRM-NOZZLE Ø 1.7 HD 10PK	10
2		TR013055CX	TRM-NOZZLE Ø 1.0 HD CP 10PK	10
		TR013056CX	TRM-NOZZLE Ø 1.4 HD CP 10PK	10
		TR013057CX	TRM-NOZZLE Ø 1.7 HD CP 10PK	10

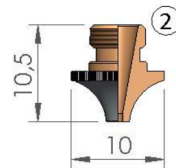
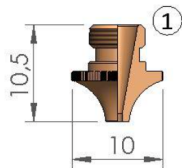

TRUMPF®				
POS	REFERENCE NUMBER	WALTH SKU	DESCRIPTION	PKG QTY
1	135320	TR013045X	TRM-NOZZLE Ø 1.0 HD 10PK	10
		TR013046X	TRM-NOZZLE Ø 1.2 HD 10PK	10
	135318	TR013047X	TRM-NOZZLE Ø 1.4 HD 10PK	10
	126157	TR013048X	TRM-NOZZLE Ø 1.7 HD 10PK	10
2	135320	TR013045CX	TRM-NOZZLE Ø 1.0 HD CP 10PK	10
		TR013046CX	TRM-NOZZLE Ø 1.2 HD CP 10PK	10
	135318	TR013047CX	TRM-NOZZLE Ø 1.4 HD CP 10PK	10
	126157	TR013048CX	TRM-NOZZLE Ø 1.7 HD CP 10PK	10

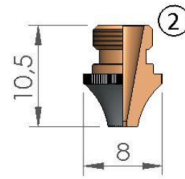
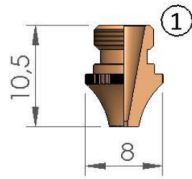

TRUMPF®				
POS	REFERENCE NUMBER	WALTH SKU	DESCRIPTION	PKG QTY
1	913799	TR013020X	TRM-NOZZLE Ø 0.8 HD EBG 10PK	10
	913800	TR013021X	TRM-NOZZLE Ø 1.0 HD EBG 10PK	10
	1487034	TR013022X	TRM-NOZZLE Ø 1.2 HD EBG 10PK	10
	913801	TR013023X	TRM-NOZZLE Ø 1.4 HD EBG 10PK	10
	937988	TR013024X	TRM-NOZZLE Ø 1.7 HD EBF 10PK	10
	0937988.20	TR013025X	TRM-NOZZLE Ø 2.0 HD EBF 10PK	10
	937989	TR013026X	TRM-NOZZLE Ø 2.3 HD EBF 10PK	10
2	913799	TR013020CX	TRM-NOZZLE Ø 0.8 HD EBG CP 10PK	10
	913800	TR013021CX	TRM-NOZZLE Ø 1.0 HD EBG CP 10PK	10
	1487034	TR013022CX	TRM-NOZZLE Ø 1.2 HD EBG CP 10PK	10
	913801	TR013023CX	TRM-NOZZLE Ø 1.4 HD EBG CP 10PK	10
	937988	TR013024CX	TRM-NOZZLE Ø 1.7 HD EBF CP 10PK	10
	0937988.20	TR013025CX	TRM-NOZZLE Ø 2.0 HD EBF CP 10PK	10
	937989	TR013026CX	TRM-NOZZLE Ø 2.3 HD EBF CP 10PK	10

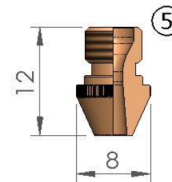
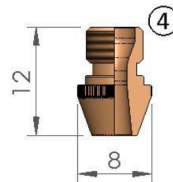
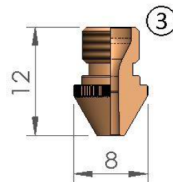
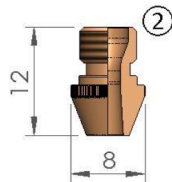
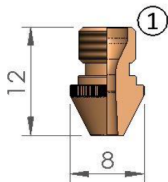

TRUMPF®				
POS	REFERENCE NUMBER	WALTH SKU	DESCRIPTION	PKG QTY
1	2241407	TR013005X	TRM-NOZZLE Ø 1.8 EBC X12 10PK	10
2	2085524	TR013007X	TRM-NOZZLE Ø 2.6 EBC X20 10PK	10
3	2241406	TR013009X	TRM-NOZZLE Ø 1.6 EBC X31 10PK	10
4	2241524	TR013011X	TRM-NOZZLE Ø 2.6 EBC X35 10PK	10
5	2241409	TR013013X	TRM-NOZZLE Ø 2.0 EBC X40 10PK	10

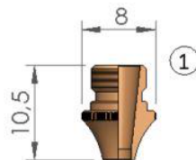

TRUMPF®				
POS	REFERENCE NUMBER	WALTH SKU	DESCRIPTION	PKG QTY
1	1546809	TR013028X	TRM-NOZZLE SLIM EBH Ø 2.75 HD 10PK	10

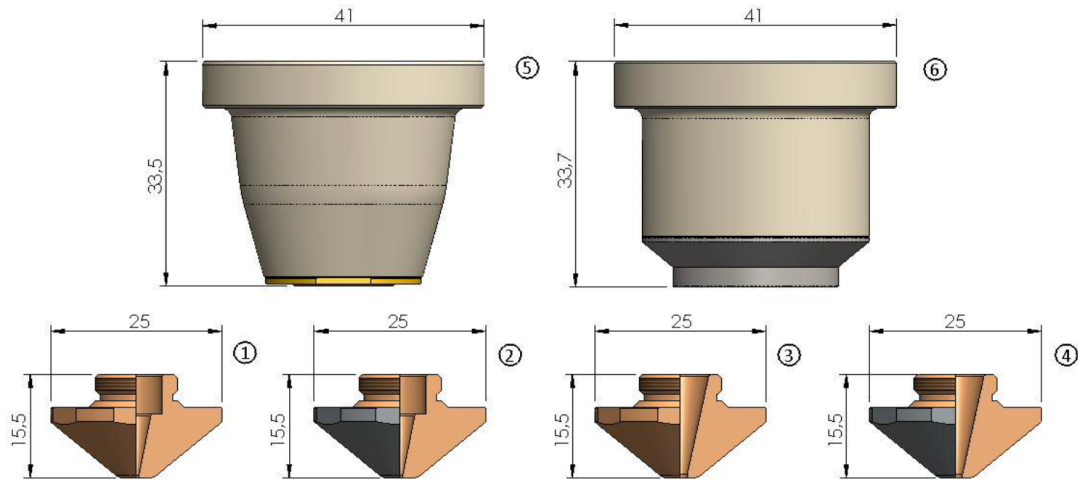

TRUMPF®

POS	REFERENCE NUMBER	WALTH SKU	DESCRIPTION	PKG QTY
1	1324858	TR011002X	TRM-NOZZLE Ø 0.8 EAA 10PK	10
	1324860	TR011003X	TRM-NOZZLE Ø 1.0 EAA 10PK	10
	1324861	TR011004X	TRM-NOZZLE Ø 1.2 EAA 10PK	10
	1324863	TR011005X	TRM-NOZZLE Ø 1.4 EAA 10PK	10
	1324864	TR011006X	TRM-NOZZLE Ø 1.7 EAA 10PK	10
2	1324858	TR011002KX	TRM-NOZZLE Ø 0.8 EAA SPC CP 10PK	10
	1324860	TR011003KX	TRM-NOZZLE Ø 1.0 EAA SPC CP 10PK	10
	1324861	TR011004KX	TRM-NOZZLE Ø 1.2 EAA SPC CP 10PK	10
	1324863	TR011005KX	TRM-NOZZLE Ø 1.4 EAA SPC CP 10PK	10
	1324864	TR011006KX	TRM-NOZZLE Ø 1.7 EAA SPC CP 10PK	10
	1324858	TR011002CX	TRM-NOZZLE Ø 0.8 EAA CP 10PK	10
	1324860	TR011003CX	TRM-NOZZLE Ø 1.0 EAA CP 10PK	10
	1324861	TR011004CX	TRM-NOZZLE Ø 1.2 EAA CP 10PK	10
	1324863	TR011005CX	TRM-NOZZLE Ø 1.4 EAA CP 10PK	10
	1324864	TR011006CX	TRM-NOZZLE Ø 1.7 EAA CP 10PK	10
3	1324865	TR011007X	TRM-NOZZLE Ø 2.0 EAA 10PK	10
	1324866	TR011008X	TRM-NOZZLE Ø 2.3 EAA 10PK	10
	1324867	TR011009X	TRM-NOZZLE Ø 2.7 EAA 10PK	10
4	1324865	TR011007KX	TRM-NOZZLE Ø 2.0 EAA SPC CP 10PK	10
	1324866	TR011008KX	TRM-NOZZLE Ø 2.3 EAA SPC CP 10PK	10
	1324867	TR011009KX	TRM-NOZZLE Ø 2.7 EAA SPC CP 10PK	10
	1324865	TR011007CX	TRM-NOZZLE Ø 2.0 EAA CP 10PK	10
	1324866	TR011008CX	TRM-NOZZLE Ø 2.3 EAA CP 10PK	10
5	1755673	TR019003	TRM-CERAMIC NZL HLDZ AUTO CHNG	1
	1349171	TR019006	TRM CERAMIC NOZZLE HOLDER	1
6	1906032	TR019007	TRM-NOZZLE HOLDER COOL LINE M12	1

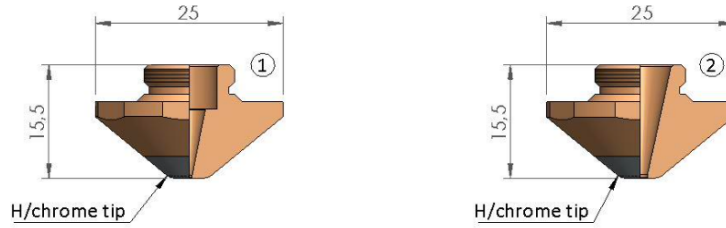

TRUMPF®				
POS	REFERENCE NUMBER	WALTH SKU	DESCRIPTION	PKG QTY
1		TR011002CK	TRM-NOZZLE Ø 0.8 EAA CP	1
		TR011002CKX	TRM-NOZZLE Ø 0.8 EAA CP 10PK	10
		TR011003CK	TRM-NOZZLE Ø 1.0 EAA CP	1
		TR011003CKX	TRM-NOZZLE Ø 1.0 EAA CP 10PK	10
		TR011004CK	TRM-NOZZLE Ø 1.2 EAA CP	1
		TR011004CKX	TRM-NOZZLE Ø 1.2 EAA CP 10PK	10
		TR011005CK	TRM-NOZZLE Ø 1.4 EAA CP	1
		TR011005CKX	TRM-NOZZLE Ø 1.4 EAA CP 10PK	10
		TR011006CK	TRM-NOZZLE Ø 1.7 EAA CP	1
		TR011006CKX	TRM-NOZZLE Ø 1.7 EAA CP 10PK	10
2		TR011007CK	TRM-NOZZLE Ø 2.0 EAA CP	1
		TR011007CKX	TRM-NOZZLE Ø 2.0 EAA CP 10PK	10
		TR011008CK	TRM-NOZZLE Ø 2.3 EAA CP	1
		TR011008CKX	TRM-NOZZLE Ø 2.3 EAA CP 10PK	10
		TR011009CK	TRM-NOZZLE Ø 2.7 EAA CP	1
		TR011009CKX	TRM-NOZZLE Ø 2.7 EAA CP 10PK	10

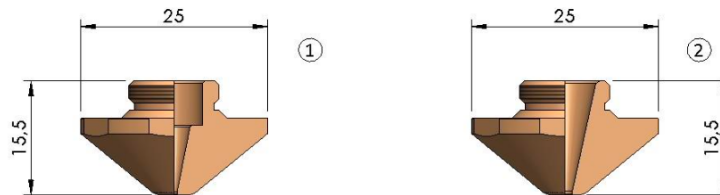

TRUMPF®				
POS	REFERENCE NUMBER	WALTH SKU	DESCRIPTION	PKG QTY
1	2488819	TR011102X	TRM-NOZZLE Ø 0.8 CAA 10PK	10
	2488864	TR011103X	TRM-NOZZLE Ø 1.0 CAA 10PK	10
	2472681	TR011104X	TRM-NOZZLE Ø 1.2 CAA 10PK	10
	2472683	TR011105X	TRM-NOZZLE Ø 1.4 CAA 10PK	10
	2488865	TR011106X	TRM-NOZZLE Ø 1.7 CAA 10PK	10
2	2472684	TR011107X	TRM-NOZZLE Ø 2.0 CAA 10PK	10
	2488868	TR011108X	TRM-NOZZLE Ø 2.3 CAA 10PK	10
	2488902	TR011109X	TRM-NOZZLE Ø 2.7 CAA 10PK	10

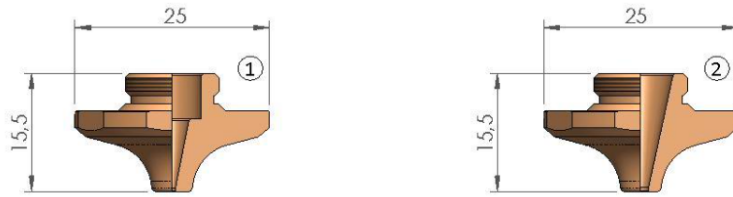

TRUMPF®				
POS	REFERENCE NUMBER	WALTH SKU	DESCRIPTION	PKG QTY
1	1373324	TR011022X	TRM-NOZZLE Ø 0.8 EAB 10PK	10
	1373325	TR011023X	TRM-NOZZLE Ø 1.0 EAB 10PK	10
	1373326	TR011024X	TRM-NOZZLE Ø 1.2 EAB 10PK	10
	1373327	TR011025X	TRM-NOZZLE Ø 1.4 EAB 10PK	10
	1373328	TR011026X	TRM-NOZZLE Ø 1.7 EAB 10PK	10
2	1373329	TR011027X	TRM-NOZZLE Ø 2.0 EAB 10PK	10
	1373330	TR011028X	TRM-NOZZLE Ø 2.3 EAB 10PK	10
	1373331	TR011029X	TRM-NOZZLE Ø 2.7 EAB 10PK	10

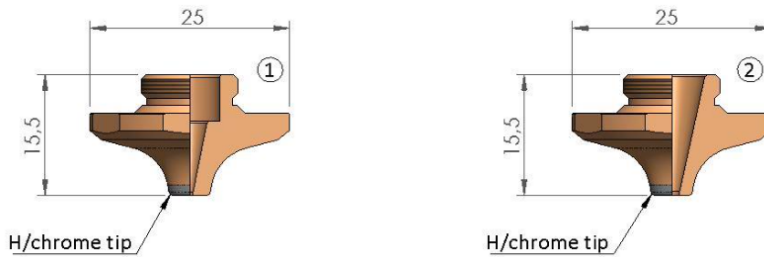

TRUMPF®				
POS	REFERENCE NUMBER	WALTH SKU	DESCRIPTION	PKG QTY
1	1373324	TR011022CK	TRM-NOZZLE Ø 0.8 EAB CP	1
	1373324	TR011022CKX	TRM-NOZZLE Ø 0.8 EAB CP 10PK	10
	1373325	TR011023CK	TRM-NOZZLE Ø 1.0 EAB CP	1
	1373325	TR011023CKX	TRM-NOZZLE Ø 1.0 EAB CP 10PK	10
	1373326	TR011024CK	TRM-NOZZLE Ø 1.2 EAB CP	1
	1373326	TR011024CKX	TRM-NOZZLE Ø 1.2 EAB CP 10PK	10
	1373327	TR011025CK	TRM-NOZZLE Ø 1.4 EAB CP	1
	1373327	TR011025CKX	TRM-NOZZLE Ø 1.4 EAB CP 10PK	10
	1373328	TR011026CK	TRM-NOZZLE Ø 1.7 EAB CP	1
1373328	TR011026CKX	TRM-NOZZLE Ø 1.7 EAB CP 10PK	10	
2	1373329	TR011027CK	TRM-NOZZLE Ø 2.0 EAB CP	1
	1373329	TR011027CKX	TRM-NOZZLE Ø 2.0 EAB CP 10PK	10
	1373330	TR011028CK	TRM-NOZZLE Ø 2.3 EAB CP	1
	1373330	TR011028CKX	TRM-NOZZLE Ø 2.3 EAB CP 10PK	10
	1373331	TR011029CK	TRM-NOZZLE Ø 2.7 EAB CP	1
1373331	TR011029CKX	TRM-NOZZLE Ø 2.7 EAB CP 10PK	10	

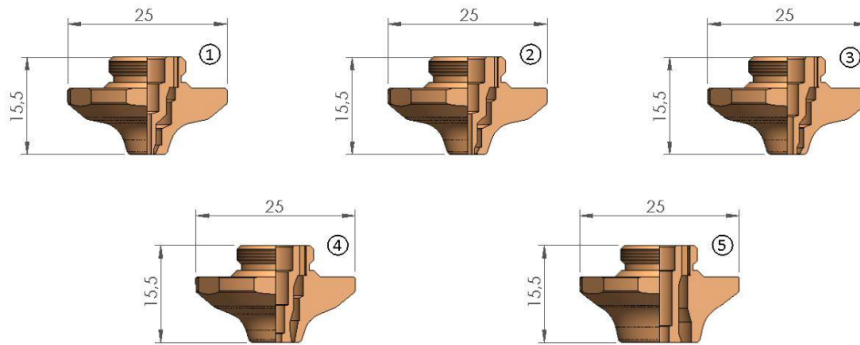

TRUMPF®

POS	REFERENCE NUMBER	WALTH SKU	DESCRIPTION	PKG QTY
1	2059462	TR014040	TRM-DOUBLE NOZZLE EAU Ø 2.5	1
2	2060001	TR014041	TRM-DOUBLE NOZZLE EAU Ø 3.0	1
3	2060004	TR014042	TRM-DOUBLE NOZZLE EAU Ø 4.0	1
4	2060025	TR014043	TRM-DOUBLE NOZZLE EAU Ø 6.0	1
5	2253595	TR014044	TRM-DOUBLE NOZZLE EAU Ø 10.0	1

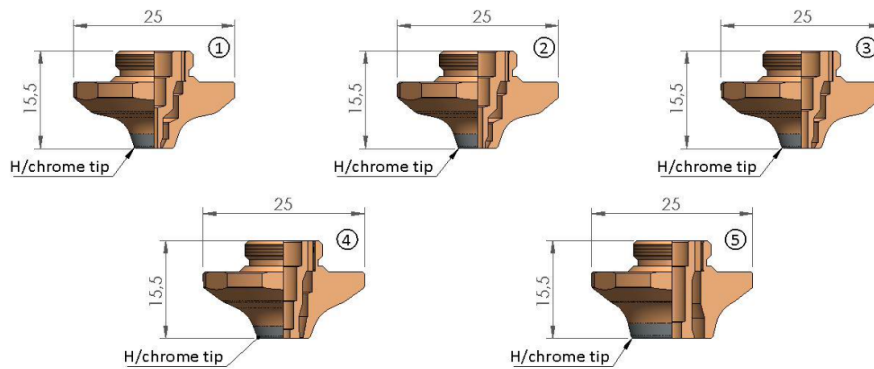

TRUMPF®

POS	REFERENCE NUMBER	WALTH SKU	DESCRIPTION	PKG QTY
1		TR014040CK	TRM-DOUBLE NOZZLE EAU Ø 2.5 CP	1
2		TR014041CK	TRM-DOUBLE NOZZLE EAU Ø 3.0 CP	1
3		TR014042CK	TRM-DOUBLE NOZZLE EAU Ø 4.0 CP	1
4		TR014043CK	TRM-DOUBLE NOZZLE EAU Ø 6.0 CP	1
5		TR014044CK	TRM-DOUBLE NOZZLE EAU Ø 10.0 CP	1



TRUMPF®

POS	REFERENCE NUMBER	WALTH SKU	DESCRIPTION	PKG QTY
1	1579549	TR014065	TRM-DOUBLE NOZZLE EAK Ø 2.5	1
	1579556	TR014066	TRM-DOUBLE NOZZLE EAK Ø 3.0	1
2	1835747	TR014067	TRM-DOUBLE NOZZLE EAK Ø 4.0	1

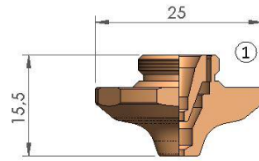

TRUMPF®				
POS	REFERENCE NUMBER	WALTH SKU	DESCRIPTION	PKG QTY
1	1664569	TR014075	TRM-DOUBLE NOZZLE EAN Ø 1.7	1
	1664602	TR014076	TRM-DOUBLE NOZZLE EAN Ø 2.0	1
	1664625	TR014077	TRM-DOUBLE NOZZLE EAN Ø 2.5	1

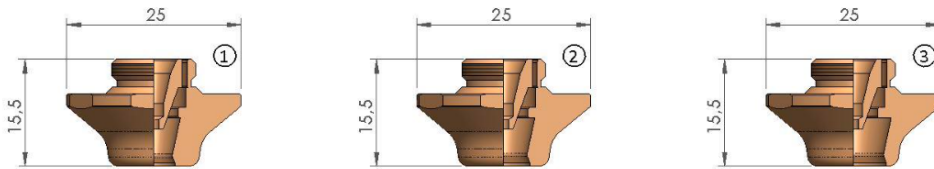

TRUMPF®				
POS	REFERENCE NUMBER	WALTH SKU	DESCRIPTION	PKG QTY
1	1809091	TR014082	TRM-DOUBLE NOZZLE EQA Ø 6.0	1
2	1809421	TR014083	TRM-DOUBLE NOZZLE EQA Ø 7.5	1
3	1886199	TR014084	TRM-DOUBLE NOZZLE EQA Ø 9.5	1

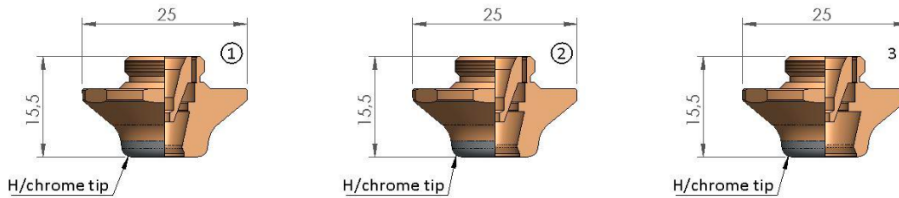

TRUMPF®				
POS	REFERENCE NUMBER	WALTH SKU	DESCRIPTION	PKG QTY
1	1809091	TR014082CK	TRM-DOUBLE NOZZLE EQA Ø 6.0 CP	1
2	1809421	TR014083CK	TRM-DOUBLE NOZZLE EQA Ø 7.5 CP	1
3	1886199	TR014084CK	TRM-DOUBLE NOZZLE EQA Ø 9.5 CP	1

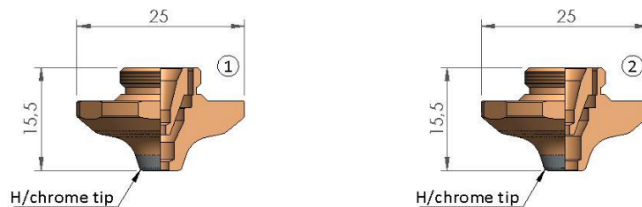

TRUMPF®				
POS	REFERENCE NUMBER	WALTH SKU	DESCRIPTION	PKG QTY
1	1579549	TR014065CK	TRM-DOUBLE NOZZLE EAK Ø 2.5 CP	1
	1579556	TR014066CK	TRM-DOUBLE NOZZLE EAK Ø 3.0 CP	1
2	1835747	TR014067CK	TRM-DOUBLE NOZZLE EAK Ø 4.0 CP	1



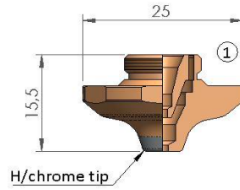

TRUMPF®				
POS	REFERENCE NUMBER	WALTH SKU	DESCRIPTION	PKG QTY
1	1664569	TR014075CK	TRM-DOUBLE NOZZLE EAN Ø 1.7 CP	1
	1664602	TR014076CK	TRM-DOUBLE NOZZLE EAN Ø 2.0 CP	1
	1664625	TR014077CK	TRM-DOUBLE NOZZLE EAN Ø 2.5 CP	1



TRUMPF®				
POS	REFERENCE NUMBER	WALTH SKU	DESCRIPTION	PKG QTY
1	1851641	TR014050	TRM-NOZZLE ECP Ø 0.8	1
	1851641	TR014050X	TRM-NOZZLE ECP Ø 0.8 10PK	10
	1851587	TR014051	TRM-NOZZLE ECP Ø 1.0	1
	1851587	TR014051X	TRM-NOZZLE ECP Ø 1.0 10PK	10
	1851588	TR014052	TRM-NOZZLE ECP Ø 1.2	1
	1851588	TR014052X	TRM-NOZZLE ECP Ø 1.2 10PK	10
	1851618	TR014053	TRM-NOZZLE ECP Ø 1.4	1
	1851618	TR014053X	TRM-NOZZLE ECP Ø 1.4 10PK	10
	1851619	TR014054	TRM-NOZZLE ECP Ø 1.7	1
	1851619	TR014054X	TRM-NOZZLE ECP Ø 1.7 10PK	10
	1851620	TR014055	TRM-NOZZLE ECP Ø 2.0	1
	1851620	TR014055X	TRM-NOZZLE ECP Ø 2.0 10PK	10
	1851651	TR014056	TRM-NOZZLE ECP Ø 2.3	1
	1851651	TR014056X	TRM-NOZZLE ECP Ø 2.3 10PK	10
	1851652	TR014057	TRM-NOZZLE ECP Ø 2.7	1
	1851652	TR014057X	TRM-NOZZLE ECP Ø 2.7 10PK	10
	2	1851641	TR014050CK	TRM-NOZZLE ECP Ø 0.8 CP
1851641		TR014050CKX	TRM-NOZZLE ECP Ø 0.8 CP 10PK	10
1851587		TR014051CK	TRM-NOZZLE ECP Ø 1.0 CP	1
1851587		TR014051CKX	TRM-NOZZLE ECP Ø 1.0 CP 10PK	10
1851588		TR014052CK	TRM-NOZZLE ECP Ø 1.2 CP	1
1851588		TR014052CKX	TRM-NOZZLE ECP Ø 1.2 CP 10PK	10
1851618		TR014053CK	TRM-NOZZLE ECP Ø 1.4 CP	1
1851618		TR014053CKX	TRM-NOZZLE ECP Ø 1.4 CP 10PK	10
1851619		TR014054CK	TRM-NOZZLE ECP Ø 1.7 CP	1
1851619		TR014054CKX	TRM-NOZZLE ECP Ø 1.7 CP 10PK	10
1851620		TR014055CK	TRM-NOZZLE ECP Ø 2.0 CP	1
1851620		TR014055CKX	TRM-NOZZLE ECP Ø 2.0 CP 10PK	10
1851651		TR014056CK	TRM-NOZZLE ECP Ø 2.3 CP	1
1851651		TR014056CKX	TRM-NOZZLE ECP Ø 2.3 CP 10PK	10
1851652		TR014057CK	TRM-NOZZLE ECP Ø 2.7 CP	1
1851652		TR014057CKX	TRM-NOZZLE ECP Ø 2.7 CP 10PK	10

Walth Corporation is not affiliated with the named manufacturers. Reference to machines, parts, descriptions, and model numbers are for convenience in verifying compatibility only. All parts are made by or for Walth Corporation and are not made by the reference manufactures (unless expressly indicated). All other trademarks are the properties of their respective owners.

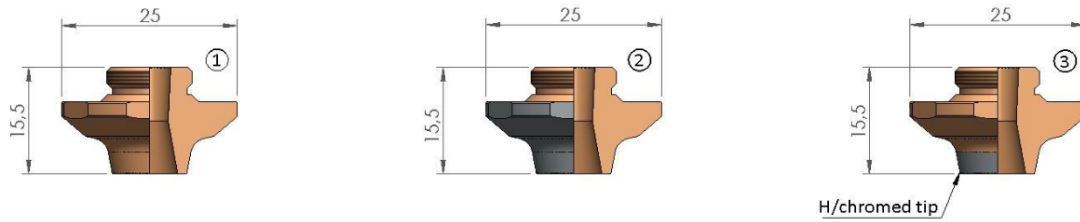

TRUMPF®				
POS	REFERENCE NUMBER	WALTH SKU	DESCRIPTION	PKG QTY
1	1633046	TR014060	TRM-NOZZLE EAC Ø 5.3	1
	1633046	TR014060X	TRM-NOZZLE EAC Ø 5.3 10PK	10
2	1633046	TR014060C	TRM-NOZZLE EAC Ø 5.3 CP	1
	1633046	TR014060CX	TRM-NOZZLE EAC Ø 5.3 CP 10PK	10
3	1633046	TR014060CK	TRM-NOZZLE EAC Ø 5.3 CP	1
	1633046	TR014060CKX	TRM-NOZZLE EAC Ø 5.3 CP 10PK	10

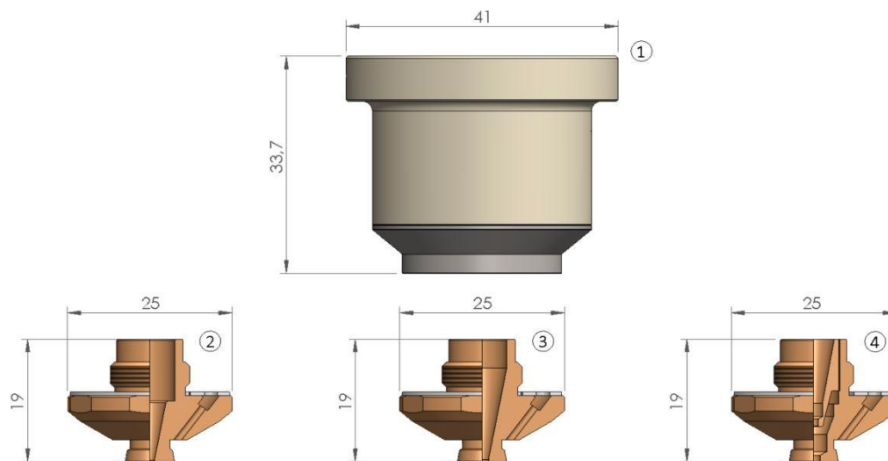

TRUMPF®				
POS	REFERENCE NUMBER	WALTH SKU	DESCRIPTION	PKG QTY
1	1906032	TR019007	TRM-NOZZLE HOLDER COOL LINE M12	1
2	1879940	TR014020	TRM-NOZZLE EGL Ø 1.4	1
	1879951	TR014021	TRM-NOZZLE EGL Ø 1.7	1
3	1879952	TR014022	TRM-NOZZLE EGL Ø 2.0	1
	1879953	TR014023	TRM-NOZZLE EGL Ø 2.3	1
4		TR014030	TRM-DOUBLE NOZZLE EGL Ø 2.0	1
		TR014031	TRM-DOUBLE NOZZLE EGL Ø 2.5	1
		TR014032	TRM-DOUBLE NOZZLE EGL Ø 3.0	1
		TR014033	TRM-DOUBLE NOZZLE EGL Ø 4.0	1

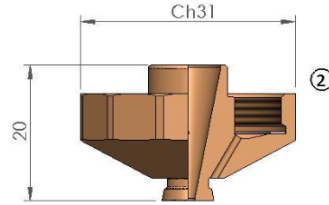
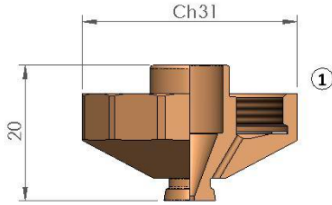

TRUMPF®

POS	REFERENCE NUMBER	WALTH SKU	DESCRIPTION	PKG QTY
1	1774018	TR015001	TRM-NOZZLE EFL Ø 1.4	1
	1838745	TR015002	TRM-NOZZLE EFL Ø 1.7	1
2	1774020	TR015003	TRM-NOZZLE EFL Ø 2.0	1
	1774092	TR015004	TRM-NOZZLE EFL Ø 2.3	1

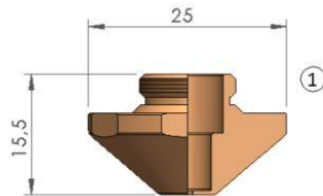

TRUMPF®

POS	REFERENCE NUMBER	WALTH SKU	DESCRIPTION	PKG QTY
1	1637264	TR014061	TRM-NOZZLE ZAA-01	1
	1637264	TR014061X	TRM-NOZZLE ZAA-01 10PK	10

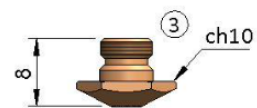
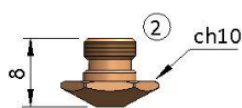
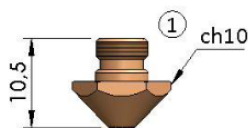

TRUMPF®

POS	REFERENCE NUMBER	WALTH SKU	DESCRIPTION	PKG QTY
1	1384753	TR013074	TRM-NOZZLE Ø 2.0 BLW OFF EBM	1
2	1736458	TR013071	TRM-NOZZLE Ø 1.0 BLW OFF EBM	1
3	1589610	TR013073	TRM-NOZZLE Ø 2.0 BLW OFF EBM	1

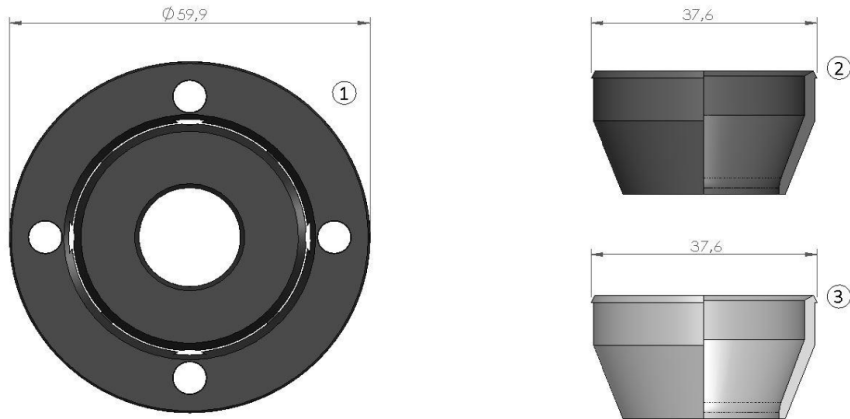

TRUMPF®

POS	REFERENCE NUMBER	WALTH SKU	DESCRIPTION	PKG QTY
1	234485	TR019020	TRM-BREAK-AWAY	1
2	256153 - 955826	TR019011	TRM-COVER-BLACK	1
3	256153 - 955826	TR019010	TRM-PTFE COVER-WHITE	1

TRUMPF®

POS	REFERENCE NUMBER	WALTH SKU	DESCRIPTION	PKG QTY
	245288	TR019027	TRM-SENSOR CABLE	1
	227833	TR019029	TRM-SENSOR CABLE 430MM BNC	1

TRUMPF®

POS	REFERENCE NUMBER	WALTH SKU	DESCRIPTION	PKG QTY
	146152	TRCP10	TRUMPF® ORIG WATER FILTER 30X68X250	1
	146152	TRCP-10	TRM-WATER FILTER 30X68X250	1

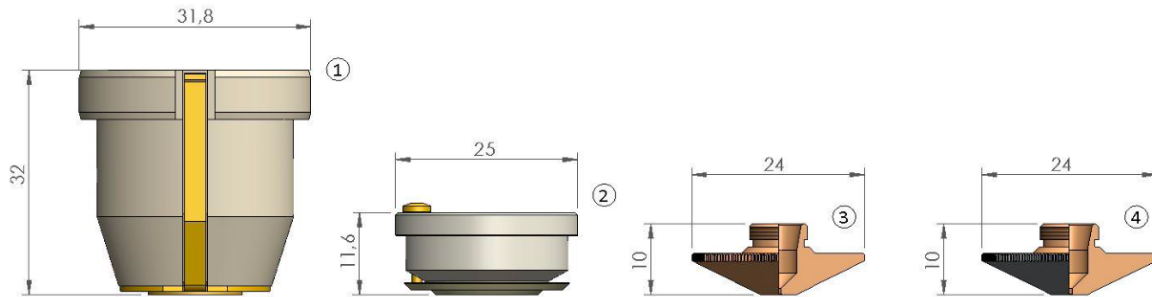

TRUMPF®

POS	REFERENCE NUMBER	WALTH SKU	DESCRIPTION	PKG QTY
1	254493 - 260432	TR019002	TRM-CERAMIC NOZZLE HOLDER	1
2	258809 - 243839 - 247894	TR019001	TRM-CERAMIC NOZZLE HOLDER	1
	258809	TR019009	TRUMPF® ORIG CERAMIC NOZZLE HOLDER	1
3	124561 - 237499	TR012001X	TRM-NOZZLE Ø 0.8 10PK	10
	124562 - 237498	TR012002X	TRM-NOZZLE Ø 1.0 10PK	10
	0966809	TR012003X	TRM-NOZZLE Ø 1.2 10PK	10
		TR012004X	TRM-NOZZLE Ø 1.4 10PK	10
	237500	TR012005X	TRM-NOZZLE Ø 1.5 10PK	10
		TR012006X	TRM-NOZZLE Ø 1.7 10PK	10
	237503 - 1253211	TR012007X	TRM-NOZZLE Ø 2.0 10PK	10
	237503	TR012008X	TRM-NOZZLE Ø 2.3 10PK	10
	237504	TR012009X	TRM-NOZZLE Ø 3.0 10PK	10
	4	0352280	TR012001CX	TRM-NOZZLE Ø 0.8 CP 10PK
0352281		TR012002CX	TRM-NOZZLE Ø 1.0 CP 10PK	10
0352282		TR012003CX	TRM-NOZZLE Ø 1.2 CP 10PK	10
		TR012004CX	TRM-NOZZLE Ø 1.4 CP 10PK	10
0352288		TR012005CX	TRM-NOZZLE Ø 1.5 CP 10PK	10
		TR012006CX	TRM-NOZZLE Ø 1.7 CP 10PK	10
		TR012007CX	TRM-NOZZLE Ø 2.0 CP 10PK	10
124564		TR012008CX	TRM-NOZZLE Ø 2.3 CP 10PK	10
		TR012009CX	TRM-NOZZLE Ø 3.0 CP 10PK	10

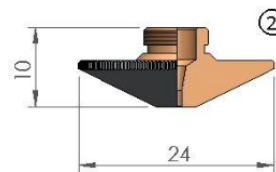
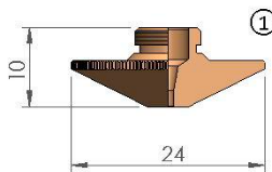

TRUMPF®

POS	REFERENCE NUMBER	WALTH SKU	DESCRIPTION	PKG QTY
1	237497	TR012017X	TRM-NOZZLE Ø 1.4 HD 10PK	10
2	352283	TR012017CX	TRM-NOZZLE Ø 1.4 HD CP 10PK	10

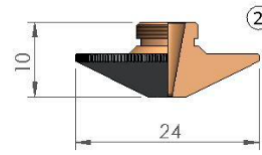
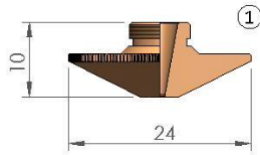

TRUMPF®

POS	REFERENCE NUMBER	WALTH SKU	DESCRIPTION	PKG QTY
1	237497/S	TR012018X	TRM-NOZZLE Ø 1.4 HD 10PK	10
	237501	TR012019X	TRM-NOZZLE Ø 1.7 HD 10PK	10
	237502	TR012020X	TRM-NOZZLE Ø 2.0 HD 10PK	10
	126933	TR012021X	TRM-NOZZLE Ø 2.3 HD 10PK	10
		TR012022X	TRM-NOZZLE Ø 2.5 HD 10PK	10
	942742	TR012023X	TRM-NOZZLE Ø 2.7 HD 10PK	10
		TR012024X	TRM-NOZZLE Ø 3.0 HD 10PK	10
2		TR012018CX	TRM-NOZZLE Ø 1.4 HD CP 10PK	10
	352284	TR012019CX	TRM-NOZZLE Ø 1.7 HD CP 10PK	10
	237502	TR012020CX	TRM-NOZZLE Ø 2.0 HD CP 10PK	10
	352285	TR012021CX	TRM-NOZZLE Ø 2.3 HD CP 10PK	10
		TR012022CX	TRM-NOZZLE Ø 2.5 HD CP 10PK	10
	352286	TR012023CX	TRM-NOZZLE Ø 2.7 HD CP 10PK	10
		TR012024CX	TRM-NOZZLE Ø 3.0 HD CP 10PK	10

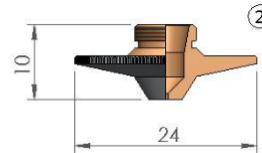
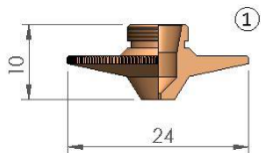

TRUMPF®

POS	REFERENCE NUMBER	WALTH SKU	DESCRIPTION	PKG QTY
1	215780	TR012011X	TRM-NOZZLE Ø 0.8 10PK	10
	87658	TR012012X	TRM-NOZZLE Ø 1.0 10PK	10
2		TR012011CX	TRM-NOZZLE Ø 0.8 CP 10PK	10
		TR012012CX	TRM-NOZZLE Ø 1.0 CP 10PK	10

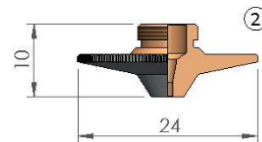
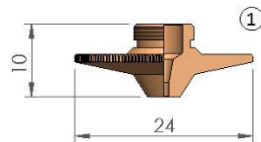

TRUMPF®

POS	REFERENCE NUMBER	WALTH SKU	DESCRIPTION	PKG QTY
1	88894	TR012026X	TRM-NOZZLE Ø 1.4 HD 10PK	10
	217867	TR012027X	TRM-NOZZLE Ø 1.7 HD 10PK	10
2	88894	TR012026CX	TRM-NOZZLE Ø 1.4 HD CP 10PK	10
	217867	TR012027CX	TRM-NOZZLE Ø 1.7 HD CP 10PK	10

Walth Corporation is not affiliated with the named manufacturers. Reference to machines, parts, descriptions, and model numbers are for convenience in verifying compatibility only. All parts are made by or for Walth Corporation and are not made by the reference manufactures (unless expressly indicated). All other trademarks are the properties of their respective owners.

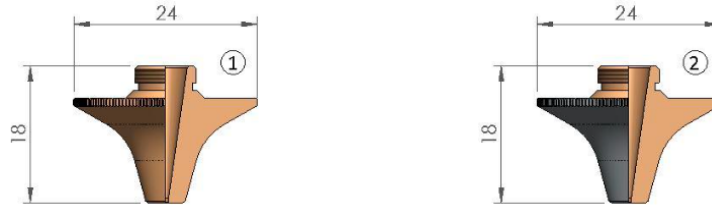

TRUMPF®				
POS	REFERENCE NUMBER	WALTH SKU	DESCRIPTION	PKG QTY
1	1277773	TR012030	TRM-NOZZLE Ø 0.8	1
	1277773	TR012030X	TRM-NOZZLE Ø 0.8 10PK	10
	1277771	TR012031	TRM-NOZZLE Ø 1.0	1
	1277771	TR012031X	TRM-NOZZLE Ø 1.0 10PK	10
	1277774	TR012032	TRM-NOZZLE Ø 1.2	1
	1277774	TR012032X	TRM-NOZZLE Ø 1.2 10PK	10
	1277776	TR012033	TRM-NOZZLE Ø 1.4	1
	1277776	TR012033X	TRM-NOZZLE Ø 1.4 10PK	10
	1277779	TR012034	TRM-NOZZLE Ø 1.7	1
	1277779	TR012034X	TRM-NOZZLE Ø 1.7 10PK	10
	1277780	TR012035	TRM-NOZZLE Ø 2.0	1
	1277780	TR012035X	TRM-NOZZLE Ø 2.0 10PK	10
	1277781	TR012036	TRM-NOZZLE Ø 2.3	1
	1277781	TR012036X	TRM-NOZZLE Ø 2.3 10PK	10
	1277782	TR012037	TRM-NOZZLE Ø 2.7	1
	1277782	TR012037X	TRM-NOZZLE Ø 2.7 10PK	10
2		TR012030C	TRM-NOZZLE Ø 0.8 CP	1
		TR012030CX	TRM-NOZZLE Ø 0.8 CP 10PK	10
		TR012031C	TRM-NOZZLE Ø 1.0 CP	1
		TR012031CX	TRM-NOZZLE Ø 1.0 CP 10PK	10
		TR012032C	TRM-NOZZLE Ø 1.2 CP	1
		TR012032CX	TRM-NOZZLE Ø 1.2 CP 10PK	10
		TR012033C	TRM-NOZZLE Ø 1.4 CP	1
		TR012033CX	TRM-NOZZLE Ø 1.4 CP 10PK	10
		TR012034C	TRM-NOZZLE Ø 1.7 CP	1
		TR012034CX	TRM-NOZZLE Ø 1.7 CP 10PK	10
		TR012035C	TRM-NOZZLE Ø 2.0 CP	1
		TR012035CX	TRM-NOZZLE Ø 2.0 CP 10PK	10
		TR012036C	TRM-NOZZLE Ø 2.3 CP	1
		TR012036CX	TRM-NOZZLE Ø 2.3 CP 10PK	10
	TR012037C	TRM-NOZZLE Ø 2.7 CP	1	
	TR012037CX	TRM-NOZZLE Ø 2.7 CP 10PK	10	

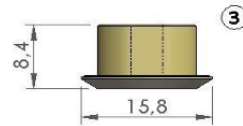
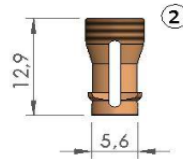
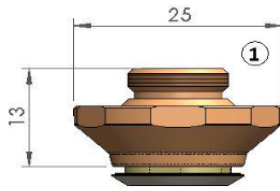

TRUMPF®

POS	REFERENCE NUMBER	WALTH SKU	DESCRIPTION	PKG QTY
1	2228806	TR014090	TRM-TOUCHDOWN NOZZLE EAV	1
2	2228802	TR019022X	TRM-INNER PART EAV Ø3.0 10PK	10
3	2284349	TR019023X	TRM-SLEEVE EAV 10PK	10

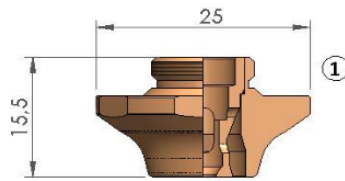

TRUMPF®

POS	REFERENCE NUMBER	WALTH SKU	DESCRIPTION	PKG QTY
1	2491660	TR014095	TRM-DOUBLE NOZZLE CAU Ø 10.0	1

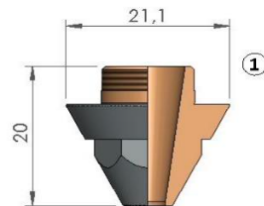

TRUMPF®

POS	REFERENCE NUMBER	WALTH SKU	DESCRIPTION	PKG QTY
1	932530	TR016001C	TRM-NOZZLE Ø 4.5 CP	1